

# 19

---

## CLOTHING AND EQUIPMENT RULES AND REGULATIONS

# CLOTHING AND EQUIPMENT RULES AND REGULATIONS

## A PREFACE

- 1 The objectives which ICC seeks to achieve through these Regulations are:
  - a) To ensure a consistent approach and to treat all Member Boards equally;
  - b) To ensure professional and appropriate standards of appearance of players and team officials;
  - c) To protect the sponsorship rights of ICC and its Member Boards (including from ambush marketing);
  - d) To allow an opportunity for players to obtain some revenue from controlled bat advertising;
  - e) To prohibit advertising connected with betting and/or gaming.
- 2 These Regulations are effective as from July 2020 and should be read in conjunction with Appendix 1, which sets out in diagrammatic form what marks and logos are permitted in what size and positions on particular items of cricket clothing and equipment in all formats of the game, and Appendix 2, which sets out the disciplinary process for breaches of these Regulations.

## B DEFINITIONS

- 1 **Betting Logo** – a Logo which is either perceived, or likely to be perceived, by spectators and viewers, as being associated or connected in some way with betting, gaming or gambling of any kind.
- 2 **Charity Logo** – an ICC Approved Logo of an officially registered charity of a Member Board's choice.
- 3 **Commercial Logo** – an ICC Approved Logo of an entity which is the sponsor of a series, event, team or player.
- 4 **Cricket Clothing** – shirts, T-shirts, skins, trousers, sweaters, caps, hats, helmets, wristbands, headbands, sunglasses or other headgear.
- 5 **Cricket Equipment** – stumps, bats, pads, boots, shoes, gloves (batting or wicket-keeping), thigh pads, arm guards and other visible protective equipment.
- 6 **Event Logo** – an ICC Approved Logo of an international cricket event, which may include (but not consist solely of) a Commercial Logo of the sponsors of the event.
- 7 **Excluded Events** – unless otherwise advised by ICC, in advance of an event, Excluded Event means: ICC Cricket World Cup, ICC Under 19 Cricket World Cup, ICC Cricket World Cup Qualifier (or replacements for any of the same), ICC World Twenty/20, ICC World Twenty/20 Qualifier, ICC Women's World Cup and the ICC Women's World Twenty/20.
- 8 **ICC Approved** – in relation to any Logo, means approved by ICC (or by ICC Development (International) Limited ('IDI') as ICC may decide) in accordance with the procedure set out in Section L below, as qualifying as a Manufacturer's Logo, a Commercial Logo, an Event Logo, a National Logo or a Player's Bat Logo (as the case may be) and as not being a Betting Logo and as being otherwise in accordance with these Regulations.

- 9 **ICC's Chief Executive Officer** – means the person appointed by the ICC from time to time to act as the ICC's Chief Executive (or his/her designee).
- 10 **ICC's Cricket Operations Department** – means the department within the ICC designated as such and which is comprised of, amongst others, the ICC's General Manager – Cricket and the ICC's Senior Cricket Operations Manager.
- 11 **ICC Events** – means each of the following: (a) the ICC Cricket World Cup; (b) the ICC World Twenty20; (c) the ICC World Cricket League Championship and World Cricket League Division 2; (d) the ICC Women's Cricket World Cup; (e) the ICC Under 19 Cricket World Cup; (f) the ICC Cricket World Cup Qualifying Tournament; (g) the ICC Women's Cricket World Cup Qualifying Tournament; (h) the ICC World Twenty20 Qualifying Tournament; (i) the ICC Under 19 Cricket World Cup Qualifying Tournament; (j) the ICC Intercontinental Cup; (k) any match or event organised or sanctioned by the ICC from time to time which is televised and/or streamed live on the Internet; and (l) any match or event organised or sanctioned by the ICC from time which the ICC deems it appropriate that these Regulations should apply.
- 12 **ICC's General Counsel** – means the person appointed by the ICC from time to time to act as the ICC's General Counsel (or his/her designee).
- 13 **ICC's General Manager – Cricket** – means the person appointed by the ICC from time to time to act as the ICC's General Manager – Cricket (or his/her designee).
- 14 **ICC's Senior Cricket Operations Manager** – means the person appointed by the ICC from time to time to act as the ICC's Senior Cricket Operations Manager (or his/her designee).
- 15 **International Match** – means each of the following (in men's and women's cricket): (a) any Test Match, One Day International Match or Twenty20 International Match; (b) any match played as part of an ICC Event; (c) any International Tour Match; or (d) any other Match organised or sanctioned by the ICC from time to time to which the ICC deems it appropriate that these Regulations should apply.
- 16 **International Tour Match** – means any match played between a representative team of a Full Member (or an Associate or Affiliate Member with ODI or T20I status) and any domestic, guest or invitational team.
- 17 **Logo** – means any form of identification or branding including (without limitation) any corporate name, business name, internet domain name, title, flag, emblem, crest, mascot or trade mark (whether registered or not and including any symbol, device or colour(s) which functions or is intended to function as a trade mark).
- 18 **Manufacturer** – in relation to any item of Cricket Clothing or Cricket Equipment, 'Manufacturer' shall mean any entity carrying on the business of both:
- manufacturing or procuring the manufacture of the Cricket Equipment or the Cricket Clothing of the type in question; and
  - supplying it from readily available stock for sale throughout outlets of several kinds to members of the public in a country which is a Member of ICC, with the aid of published price lists and catalogues, and with profit directly from the sale of such Cricket Clothing or Cricket Equipment as its main aim.



An entity not otherwise within this definition shall not qualify as a Manufacturer by reason of its being associated in business with, or a company in the same group of companies as a Manufacturer.

No entity shall qualify as a Manufacturer of any item of Cricket Clothing or Cricket Equipment by virtue of its involvement in the manufacture of Cricket Clothing or Cricket Equipment of any other type. In particular (but without prejudice to the generality of the foregoing), no entity shall qualify as a Manufacturer of bats by reason of its manufacture of any other item of Cricket Equipment or Cricket Clothing.

An entity which as of October 2001 qualified as a 'Manufacturer' under the previous edition of these Regulations but which would not otherwise qualify as a Manufacturer hereunder shall be deemed to continue to qualify as a Manufacturer provided the Logo of any such entity shall not thereby qualify as a Manufacturer's Logo if it is a Betting Logo.

**19 Manufacturer's Logo** – an ICC Approved Logo of the Manufacturer of the item of Cricket Equipment or Cricket Clothing in question excluding, however:

- a) any Logo which (notwithstanding some connection with a Manufacturer) is also (either at the time of its adoption or subsequently) a Logo of, confusingly similar to or which suggests a connection with any entity which is not a Manufacturer; and
- b) any Betting Logo.

provided, however, that ICC may (in its sole discretion) approve as a Manufacturer's Logo, a Logo of an entity which, although not already a Manufacturer, is nevertheless a manufacturer of sports clothing and/or sports equipment other than Cricket Clothing and Cricket Equipment.

For the purpose of these Regulations (including Appendices 1 and 2), all Manufacturer's Logos shall fall into one of the following five categories:

- **Design Feature** – means any design feature of a Manufacturer which is distinctive to that Manufacturer and is used for the purposes of brand identification and/or cosmetic appeal but which does not contain any Manufacturer's Identification.
- **Identification Strip** – a tone on tone or contrasting strip containing a Manufacturer's Identification once or repeatedly.
- **Manufacturer's Identification** – means any express form of Manufacturer identification, including but not limited to a Manufacturer's name, model name, internet domain name, emblem, logo and/or trademark, but shall not include any Design Feature.
- **Official Product** – means the label which identifies an item as an official product of the Manufacturer.
- **Quality Feature** – means the label of the Manufacturer which promotes a quality feature used by the Manufacturer.

**20 National Logo** – an ICC Approved Logo of a country or its ICC Member Board.

**21 Non-Commercial Logo** – an ICC Approved Personal Message, visible tattoo or other Logo, which is not a Manufacturer's Logo, Commercial Logo, Player's Bat Logo, Betting Logo, Event Logo, Charity Logo or National Logo.

- 22 **Official ICC Apparel Supplier** – means a supplier of apparel contracted by ICC or IDI, from time to time, to supply apparel to the ICC, IDI and the ICC umpires and referees.
- 23 **Personal Message** – has the meaning ascribed to it in clause G1 below.
- 24 **Player's Bat Logo** – means an ICC Approved Logo of a sponsor of a player to be carried on the player's bat; provided that such Logo shall not be either:
- a) of, or confusingly similar to, or likely to be perceived as suggesting a connection with:
    - 1) an entity which conflicts (whether through being a competitor or otherwise) with the exclusivity of any sponsor, supplier, or commercial partner of the Member Board of the player concerned or of an ICC Event; or
    - 2) a Manufacturer, other than the Manufacturer of the item of cricket equipment it is to be carried on; or
  - b) a Betting Logo.
- ICC shall have the final say in determining whether any such conflict or circumstances exist and no player may pursue any action against ICC or IDI, or against his team's ICC Member Board should he be precluded from displaying a Player's Bat Logo by reason of the same.

## C SCOPE OF APPLICATION

- 1 These Regulations shall apply to all International Matches. Contractual agreements (for example Member Participation Agreements and Player Squad Terms) and regulations pertaining specifically to individual ICC Events should also be consulted regarding specific instructions concerning clothing and equipment at such ICC Events. Where any conflict arises between these Regulations and the obligations contained in any specific ICC Event agreement and/or regulation, then the ICC Event specific agreement and/or regulations shall prevail.

**NOTE:** One example of where the regulations governing ICC Events differ from these Regulations is that Player's Bat Logos and Charity Logos shall not be permitted in Excluded Events. Accordingly, all players, agents, sponsors and manufacturers should ensure that they obtain a copy of any applicable agreements and/or regulations before finalising any arrangements that relate to the commercialisation of relevant cricket clothing and equipment during or in relation to any ICC Event.

- 2 These Regulations govern the authorisation of clothing and equipment worn and used by players and team officials of Member Board representative teams. Sponsor advertising, manufacturer identification and the decorative rights of the Member Boards are also addressed.
- 3 The aforesaid persons are subject to these provisions when on official duty for the aforesaid matches, either on the field of play or as otherwise expressly stated.
- 4 These Regulations also cover sponsor advertising and manufacturer identification on stumps.

## D GENERAL PROHIBITIONS

- 1 Any clothing or equipment that does not comply with these Regulations is strictly prohibited. In particular, no Logo shall be permitted to be displayed on Cricket Clothing or Cricket Equipment, other than a National Logo, a Commercial Logo, an Event Logo, a Manufacturer's Logo, a Player's Bat Logo, a Charity Logo or a Non-Commercial Logo as provided in these Regulations. In addition, where any Match Official becomes aware of any clothing or equipment that does not comply with these Regulations, he shall be authorised to prevent the offending person from taking the field of play (or to order them from the field of play, if appropriate) until the non-compliant clothing or equipment is removed or appropriately covered up.
- 2 It shall also be prohibited under these Regulations for any individual to wear any clothing or use any equipment that has been changed, altered or transformed (whether to comply with these Regulations or otherwise) in any way that, in the opinion of any Match Official, undermines the professional standards that are required of all elite players. For example, and without limitation, it shall be prohibited to cover up or alter the appearance of clothing and equipment with sticking plaster or marker pens and/or to wear batting pads painted with a coloured paint that has faded or is flaking off.
- 3 For the avoidance of doubt, there shall be no requirement that a Match Official must first provide a warning to the offending individual to remove or cover up a prohibited logo before a breach of these Regulations can be established.

## E CONTRASTING COLOURED KIT FOR HOME AND AWAY MATCHES

- 1 For teams participating in a televised bi-lateral ODI or T20I, it is necessary to be able to distinguish between the teams on the field of play. Teams are therefore required to wear contrasting coloured kit.
- 2 To be determined in advance of a series, the home team has preference in the choice of colour. The participating teams should agree in the respective MOU the colour of the kit the visiting team will wear if there is a clash of colour.
- 3 For televised ICC events all participating teams will be required to provide for two different coloured kits, except for the host country who has preference in the choice of colour and may, if it chooses to do so, provide only one coloured kit to be worn in all matches throughout the event. In advance of the event the teams will be notified which coloured kit will be worn in each match.

## F LOGOS – GENERAL PRINCIPLES

- 1 In the case of the host team, the Commercial Logos may consist of the Event Logo and/or the Logos of up to three event, series or team sponsors. In the case of the visiting team the Commercial Logos may consist of the Logos of up to three team sponsors. For the avoidance of any doubt, no more than three sponsor names may be included in any Commercial Logo.
- 2 Subject to the limitations contained in these Regulations a visiting team may display any Commercial Logo on its clothing or equipment irrespective of whether such Logos may conflict with any sponsor or supplier of the host Member Board.



- 3 The host Member Board shall not require a visiting team to wear the Event Logo without the consent of the Board of the visiting team. There shall be no obligation to give such consent, but if it is given, the visiting team must forego the use by its team sponsors of one of the two Commercial Logos.
- 4 Any Commercial Logo on clothing shall be decided by each Member Board and shall be common to and worn by each member of the team concerned. No individual Commercial Logos shall be worn by any team member, save for the carrying of a Player's Bat Logo on bats, as provided herein.
- 5 The National Logo, name of the country or national flag should not contain any advertising and must not interfere with any elements of the clothing identifying the player.
- 6 A visiting team shall abide by any law of the host country which restricts advertising of a product. No compensation shall be payable should a visiting team be precluded from displaying its Commercial Logos on Cricket Clothing or Cricket Equipment, and a visiting team shall not pursue any action against the host Member Board.
- 7 Only one Manufacturer may be identified on each article of cricket clothing and cricket equipment.
- 8 When required to be carried by a Manufacturer, any statutory wording is to be placed on the back of a player's bat and to be of discreet design only (subject to relevant statutory provisions).

## G PERSONAL MESSAGES

- 1 Players and team officials shall not be permitted to wear, display or otherwise convey personal messages on their clothing, equipment or otherwise, irrespective of whether such messages are affixed to clothing, equipment or otherwise and whether such messages are displayed or conveyed through the use of the specific clothing or other items (e.g. an arm band) or by the use of words, symbol, graphic message, images or otherwise ("**Personal Messages**"), unless approved in advance by both the player or team official's Board and the ICC Cricket Operations Department. Approval shall not be granted for messages which relate to political, religious or racial activities or causes. The ICC shall have the final say in determining whether any such message is approved. For the avoidance of doubt, where a message is approved by the player or team official's Board but subsequently disapproved by the ICC's Cricket Operations Department, the player or team official shall not be permitted to wear, display or otherwise convey such message in International Matches.

**GUIDANCE NOTE:** In determining whether a message is for a “political, religious or racial cause”, the starting point is that the ICC and its Members acknowledge and agree that cricket should be used as a tool to bring people and communities around the world together and not as a platform to draw attention to potentially divisive political issues, rhetoric or agendas. Each case must be considered on its own facts and the ICC will take into account all relevant circumstances, including (as it sees fit): (a) the views of any other relevant team or individual; (b) the likely sentiment and response in the media to the message in all relevant countries; (c) whether the message is a ‘one-off’ or whether it is to be displayed for a longer period; (d) the purpose and impact of conveying the message. By way of example only, and without limitation, where the purpose of a message appears to be commemorative in nature (e.g. the use of a black armband or a poppy) or to serve a charitable purpose (e.g. to generate funds or awareness for a non-political charitable cause), it is more likely to be permitted; where a message appears to indicate support for a particular government, political party or individual, it is more likely to be prohibited. Where a request for approval is submitted to the ICC, the ICC shall be entitled to request such further information as it considers necessary before making its decision and to impose such conditions as it sees fit in providing its approval (as applicable).

- 2 Visible Tattoos (permanent or temporary) incorporating any Commercial or Manufacturer’s Logo shall not be permitted.

## H TRAINING CLOTHING

- 1 Team Training Bibs: Shall be of a distinguishing colour to that of the playing shirts.
- 2 Only training kit (which shall include tracksuits, sweatshirts, branded T-shirts, team training bibs etc.) issued to the team by its Board (hereinafter referred to as team training kit) may be worn by the players and team officials within the precincts of the ground on match days as well as at all official team practice and training sessions.
- 3 Save for the requirement in the relevant playing conditions that squad members of the fielding team who are not playing in the match and who are not acting as substitute fielders shall be required to wear a team training bib whilst on the playing area (including the area between the boundary and the perimeter fencing). No training kit is to be worn by players on the field during the hours of play.
- 4 Subject to the provisions of paragraphs F1, F6 and H1, and the proviso that the team training kit is uniform to all members of the same team, and other than in the case of Excluded Events, there shall be no restriction on the colour or design of the team training kit nor on the number, positioning and size of the National, Commercial or Manufacturer’s Logos thereon.

## I TOSS

Players attending at the toss will be expected to be in team playing clothing. Team blazers shall be optional.



## J PRESS CONFERENCES, POST- MATCH PRESENTATIONS AND TELEVISION INTERVIEWS

Players or team officials attending post match presentation ceremonies and press conferences as well as television interviews conducted during or after the match shall be expected to be in either team playing clothing, team training kit excluding vests and shorts or other appropriate team clothing.

## K MEASUREMENT METHOD

Items will be measured according to their geometric shape. To calculate the surface area, items may be divided into several geometric forms. Non standard shapes will be measured as rectangles.

## L ICC APPROVAL

- 1 In order for any Logo or Personal Message to be ICC Approved for use in any match or series of matches to which these Regulations apply, the party seeking approval (e.g. the entity claiming to be the Manufacturer in the case of approval sought for a Manufacturer's Logo) must apply to ICC for the grant of such approval as set out in clause 2 below and such approval must have been granted in advance of the commencement of the match or series in question. Once a Logo or Personal Message has been ICC Approved for any relevant match or series of matches, such approval shall remain effective for all other applicable matches and series thereafter until either:
  - a) such time as these Regulations may be amended or replaced in any way affecting the continuing compliance of such Logo or Personal Message in which case the Logo or Personal Message shall cease to be approved immediately unless the Logo or Personal Message is being used in a match or series at the time of ICC giving notice of the amendment or replacement of the Regulations or is due to be used in such a match or series within 30 days after such notice in which case such approval will cease to apply to the Logo or Personal Message concerned at the end of the match or series in question; or
  - b) until ICC gives notice that the Logo or Personal Message is no longer ICC Approved due to it ceasing to be in compliance with these Regulations from time to time (e.g. that since the original grant of ICC Approval, the Logo has become a Betting Logo) in which case the Logo or Personal Message will cease to be ICC approved immediately upon ICC giving notice to that effect.
- 2 Any application to ICC for a Logo or Personal Message to be ICC Approved shall be sent to ICC at Dubai Sports City, PO Box 500070, Dubai, marked 'Cricket Operations Department'. The application shall state the type of Logo for which the approval is sought (e.g. whether a Manufacturer's Logo, a Player's Bat Logo, etc.) or shall set out the wording of the proposed Personal Message and shall include a sample of the Logo or Personal Message for the item of Cricket Clothing or Cricket Equipment to which it is proposed (subject to approval being granted) to be applied. In respect of any Logo which is required by these Regulations to be within certain size parameters, the applicant must state the size which it considers such Logo to be and provide evidence of how this has been calculated. ICC retains the final say in determining whether any Logo is within the permitted parameters.

- 3 ICC will review any application for a Logo or Personal Message to be ICC Approved which has been received in accordance with clause 2 above and within 3 days of receipt of such application (counting from the first business day on which, or following which, the application was received and discounting any intervening days which are not regular business days – e.g. weekends and public holidays) shall respond to the applicant, acknowledging receipt of the application and, if applicable, confirming that ICC has been provided with the required information and materials or, alternatively, stating that ICC considers that it has not been provided with all requisite details/materials as set out in clause 2 above and requesting that the applicant provides the same.
- 4 ICC shall use its best endeavours (but does not undertake) to provide its final determination to the applicant for a Logo or Personal Message to be ICC Approved within 10 business days of its having confirmed receipt of all requisite information and materials for such application.

#### **M BREACH OF REGULATIONS BY PLAYERS AND BOARDS**

In the event of a breach by any player, team official or Board of these Regulations, the disciplinary process and sanctions set out in Appendix 2 shall apply. For the avoidance of doubt, a Board may breach these Regulations in circumstances where it issues equipment or clothing to a player or team official which does not comply with the terms of these Regulations.

#### **N BREACH OF REGULATIONS BY MANUFACTURERS**

In the event that any Manufacturer, in the absolute discretion of the ICC, repeatedly breaches the terms of these Regulations, the ICC reserves the right to revoke any approval granted to such Manufacturer pursuant to paragraph K above upon written notice to the Manufacturer. Any such revocation of approval shall take effect from the date specified in the written notice.





# APPENDIX 1

## CLOTHING AND EQUIPMENT

### TEST MATCHES

PLAYING SWEATER – LONG SLEEVED.....	19.12
PLAYING SHIRT – SLEEVELESS.....	19.14
PLAYING SHIRT.....	19.16
PLAYING TROUSERS.....	19.18
PLAYING CAP AND SUNHAT.....	19.20

### ONE DAY INTERNATIONALS

PLAYING SWEATER – LONG SLEEVED.....	19.22
PLAYING SHIRT – SLEEVELESS.....	19.24
PLAYING SHIRT.....	19.26
PLAYING TROUSERS.....	19.28
PLAYING CAP AND SUNHAT.....	19.30

### T20 INTERNATIONALS

PLAYING SWEATER – LONG SLEEVED.....	19.32
PLAYING SHIRT – SLEEVELESS.....	19.34
PLAYING SHIRT.....	19.36
PLAYING TROUSERS.....	19.38
PLAYING CAP AND SUNHAT.....	19.40

### OTHER CLOTHING

TEAM TRAINING BIB.....	19.42
T-SHIRTS.....	19.43
SKINS.....	19.44
SOCKS.....	19.45
TURBANS, BANDANAS AND HIJABS.....	19.46
HEADBANDS AND WRISTBANDS.....	19.47

### CRICKET EQUIPMENT

CRICKET BAT.....	19.48
WICKET KEEPER GLOVES.....	19.49
BATTING GLOVES.....	19.50
HELMET.....	19.51
WICKET KEEPER PADS.....	19.52
BATTING PADS.....	19.53
SHOES AND BOOTS.....	19.54
SUN GLASSES.....	19.55
ARM GUARDS.....	19.56
FACE PROTECTOR.....	19.57
STUMPS.....	19.58
THIGH PADS, SHIN PROTECTORS AND OTHER EQUIPMENT.....	19.59

# TEST MATCHES

## PLAYING SWEATER – LONG SLEEVED

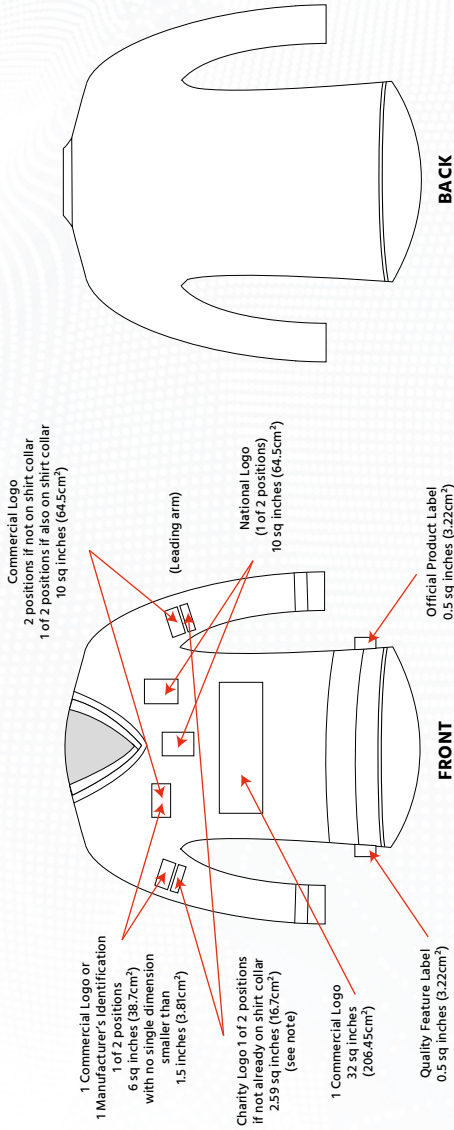

NOTE: Zips, poppers, buttons and Velcro are not permitted anywhere from the bottom up to the chest

## NOTE

COLOUR AND DESIGN	NAME, NUMBER AND INITIALS	OTHER MARKS AND INSIGNIA
<ul style="list-style-type: none"> <li>The colours and design of the sweaters (including Logos) shall be uniform to all members of the same team.</li> <li>Sweaters shall be plain white/cream, save that coloured piping or trim and stripes shall be permitted subject to the following restrictions:               <ul style="list-style-type: none"> <li>Piping is restricted to 0.5 cm (0.2 in) in width.</li> <li>Only one colour of piping/trim is permitted on any sweater.</li> <li>Piping is restricted to the sweater seams.</li> <li>Stripes in team colours are permitted around the waist, neck (traditional V shape) and wrist cuffs.</li> </ul> </li> </ul>	<ul style="list-style-type: none"> <li>One of the following numbers is permitted to be displayed on the long sleeved sweaters in a position immediately below the National Logo on the front of the sweater:               <ul style="list-style-type: none"> <li>Indicating a player's order of selection for his country, or</li> <li>Indicating the number of caps earned by a player for his country, or</li> <li>Indicating a player's landmark achievement (50, 100, 150 Tests etc).</li> </ul> </li> <li>Such numbers shall not be more than 2 cm (0.78 in) in height.</li> <li>A player's initials may be displayed on the chest or sleeve of the long sleeved sweater. Such initials shall not be more than 2 cm (0.78 in) in height.</li> </ul>	<ul style="list-style-type: none"> <li>Players representing Member Boards who have won the ICC Test Play-off may display a symbol on the sweater for each of the occasions that this has been achieved. No restrictions on position. Each symbol shall not exceed 1 sq cm in size.</li> <li>The name of the opposing touring team or the name of the country being toured as well as the year of such tour may be displayed on the chest of the sweater immediately below the National Logo provided such numbers and letters shall not exceed 1 cm (0.4 in) in height.</li> <li>Charity ribbons/logos that are worn on team uniforms must be transferred on to the uniform. Stick on logos are also permitted. Ribbons/logos with pins are not permitted.</li> </ul>



# TEST MATCHES

## PLAYING SWEATER – SLEEVELESS

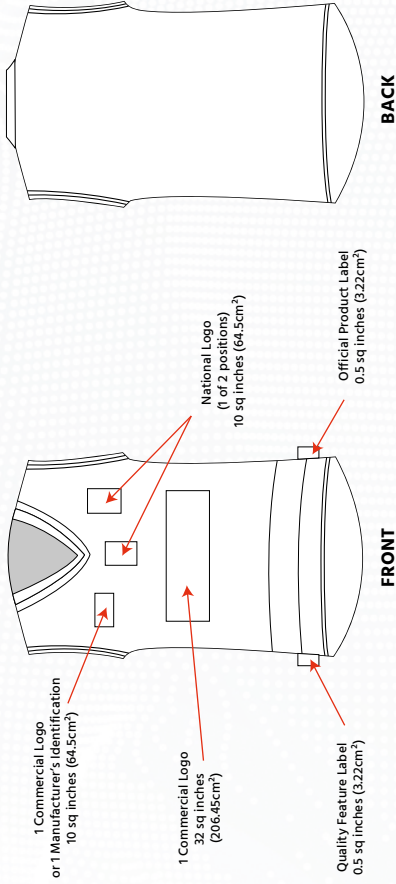

NOTE: Zips, poppers, buttons and Velcro are not permitted anywhere from the bottom up to the chest

## NOTE

COLOUR AND DESIGN	NAME, NUMBER AND INITIALS	OTHER MARKS AND INSIGNIA
<ul style="list-style-type: none"> <li>The colours and design of the sweaters (including Logos) shall be uniform to all members of the same team.</li> <li>Sweaters shall be plain white/cream, save that coloured piping or trim and stripes shall be permitted subject to the following restrictions:               <ul style="list-style-type: none"> <li>Piping is restricted to 0.5 cm (0.2 in) in width.</li> <li>Only one colour of piping/trim is permitted on any sweater.</li> <li>Piping is restricted to the sweater seams.</li> <li>Stripes in team colours are permitted around the waist and neck (traditional V shape).</li> </ul> </li> </ul>	<ul style="list-style-type: none"> <li>One of the following numbers is permitted to be displayed on the sleeveless sweaters in a position immediately below the National Logo on the front of the sweater:               <ul style="list-style-type: none"> <li>Indicating a player's order of selection for his country, or</li> <li>Indicating the number of caps earned by a player for his country, or</li> <li>Indicating a player's landmark achievement (50, 100, 150 Tests etc).</li> <li>Such numbers shall not be more than 2 cm (0.78 in) in height.</li> </ul> </li> <li>A player's initials may be displayed on the chest of the sleeveless sweater. Such initials shall not be more than 2 cm (0.78 in) in height.</li> </ul>	<ul style="list-style-type: none"> <li>Players representing Member Boards who have won the ICC Test Play-off may display a symbol on the sweater for each of the occasions that this accomplishment has been achieved. No restrictions on position. Each symbol shall not exceed 1 sq cm in size.</li> <li>The name of the opposing touring team or the name of the country being toured as well as the year of such tour may be displayed on the chest of the sleeveless sweater immediately below the National Logo provided such numbers and letters shall not exceed 1 cm (0.4 in) in height.</li> </ul>

# TEST MATCHES

## PLAYING SHIRT

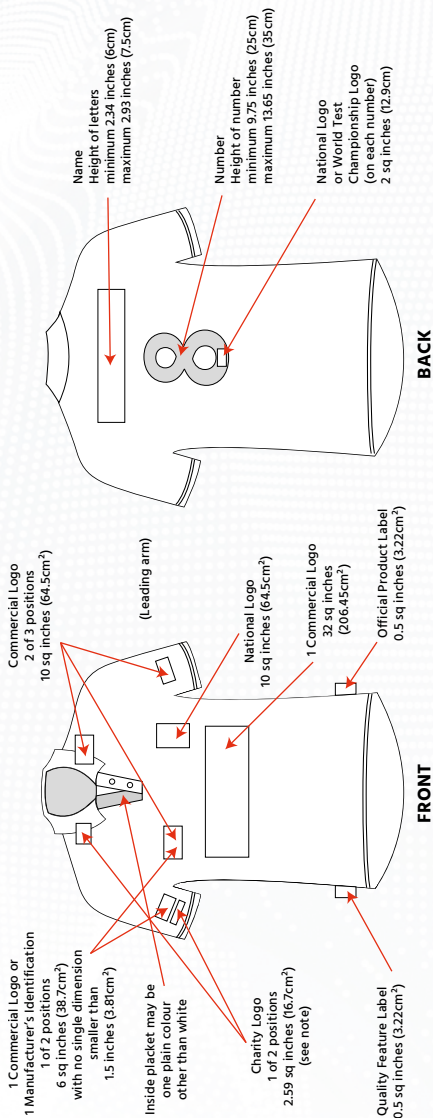

NOTE: Zips, poppers, buttons and Velcro are not permitted anywhere from the bottom up to the chest  
NOTE: The World Test Championship Logo displayed in the number shall be white only



## NOTE

COLOUR AND DESIGN	NAME, NUMBER AND INITIALS	OTHER MARKS AND INSIGNIA
<ul style="list-style-type: none"> <li>The colours and design of the shirts (including Logos) shall be uniform to all members of the same team. Playing shirt sleeves may be cut to any length, as long as both sleeves are evenly trimmed and the edges are sewn and hemmed.</li> <li>Playing shirts shall be plain white/cream, save that coloured piping or trim shall be permitted subject to the following restrictions.               <ul style="list-style-type: none"> <li>Piping is restricted to 0.5 cm (0.2 in) in width.</li> <li>Only one colour of piping/trim is permitted on any shirt.</li> <li>Piping is restricted to the edge of the shirt collar, shirt seams and cuffs.</li> <li>The inside of the placket may be of a plain colour other than white.</li> </ul> </li> </ul>	<ul style="list-style-type: none"> <li>Effective from 1st August 2019, the names and numbers of players carried on the playing shirts shall correctly reflect the identity of the player. The number on the shirts shall be clearly legible, positioned in the centre back of the shirt.</li> <li>The range of permitted numbers is 1 – 99.</li> <li>The numbers shall be sewn on or fixed by heat transfer and not affixed by Velcro or any temporary means.</li> <li>The names must be positioned above the number on the back of the shirt and the letters used must be clearly legible.</li> <li>The names and numbers may not contain any advertising elements.</li> <li>One of the following numbers is permitted to be displayed on the playing shirts in a position immediately below the National Logo on the front of the shirt:               <ul style="list-style-type: none"> <li>Indicating a player's order of selection for his country, or</li> <li>Indicating the number of caps earned by a player for his country, or</li> <li>Indicating a player's landmark achievement (50, 100, 150 Tests etc.).</li> </ul> </li> <li>Such numbers shall not be more than 2 cm (0.78 in) in height.</li> <li>A player's initials may be displayed on the chest or sleeve of the playing shirt. Such initials shall not be more than 2 cm (0.78 in) in height.</li> </ul>	<ul style="list-style-type: none"> <li>Teams participating in the ICC World Test Championship may display the year the country played its first Test Match above the National Logo. Such numbers shall not exceed 1cm (0.4in).</li> <li>Teams participating in the ICC World Test Championship final may display the names of the competing teams and the date and venue of the final below the National Logo. Such letters and numbers shall not exceed 1 cm (0.4 in).</li> <li>The name of the opposing touring team or the name of the country being toured as well as the year of such tour may be displayed on the chest of the playing shirt immediately below the National Logo provided such numbers and letters shall not exceed 1 cm (0.4 in) in height.</li> <li>Charity ribbons/logos that are worn on team uniforms must be transferred on to the uniform. Stick on logos are also permitted. Ribbons/logos with pins are not permitted.</li> </ul>

# TEST MATCHES

## PLAYING TROUSERS

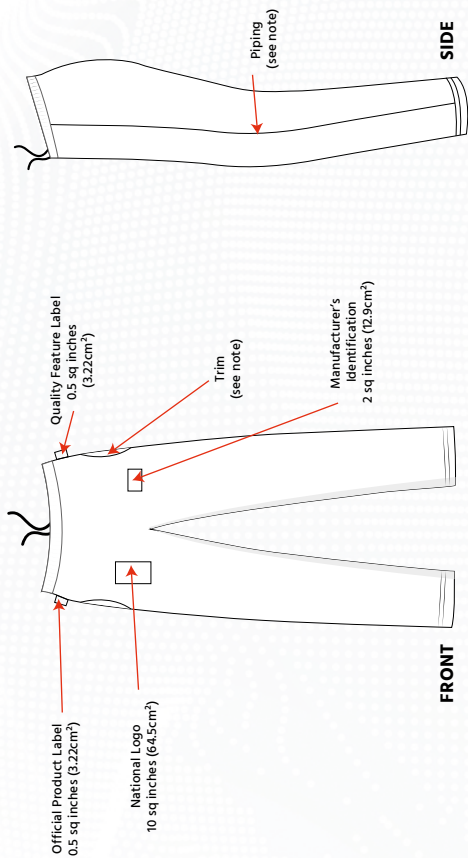

NOTE: Zips, poppers, buttons and Velcro are not permitted anywhere from the knee up to the waist

**NOTE**

COLOUR AND DESIGN	NAME, NUMBER AND INITIALS	OTHER MARKS AND INSIGNIA
<ul style="list-style-type: none"><li>• Trousers shall be plain white/cream, save that coloured piping or trim shall be permitted subject to the following restrictions:<ul style="list-style-type: none"><li>• Piping is restricted to 0.5 cm (0.2 in) in width.</li><li>• Piping is restricted to the edge of the pockets and the outside seam of the leg of the trousers.</li><li>• Only one colour of piping/trim is permitted and shall be the same colour as the piping/trim, if any, on the playing shirt.</li><li>• If coloured piping/trim is used, the colour and design of the trousers (including Logos) shall be uniform to all members of the same team.</li><li>• The inside of the pocket may be of a plain colour other than white/cream.</li></ul></li></ul>	<ul style="list-style-type: none"><li>• None permitted.</li></ul>	<ul style="list-style-type: none"><li>• None permitted.</li></ul>



# TEST MATCHES

## PLAYING CAP AND SUN HAT

19.20

National Logo  
10 sq inches (64.5cm<sup>2</sup>)

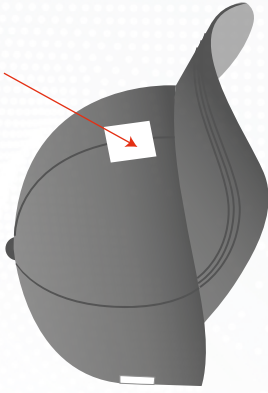
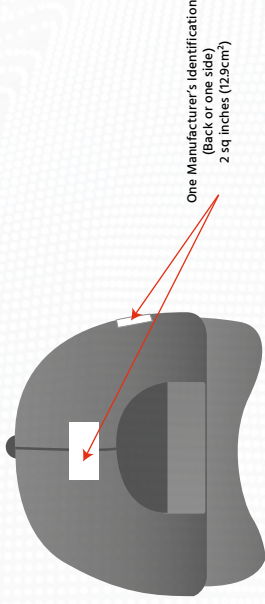
**FRONT****BACK**

One Manufacturer's Identification  
(Back or one side)  
2 sq inches (12.9cm<sup>2</sup>)

## NOTE

COLOUR AND DESIGN	NAME, NUMBER AND INITIALS	OTHER MARKS AND INSIGNIA
<ul style="list-style-type: none"> <li>• Colour – Caps and sunhats must be the same colour to all members of the same team. As an alternative, a white sunhat may be worn.</li> <li>• Design – The design of the cap and sunhat shall be uniform to all members of the same team.</li> </ul>	<ul style="list-style-type: none"> <li>• One of the following numbers is permitted to be displayed on the caps and sunhats in a position immediately below the National Logo:               <ul style="list-style-type: none"> <li>• Indicating a player's order of selection for his country, or</li> <li>• Indicating the number of caps earned by a player for his country, or</li> <li>• Indicating a player's landmark achievement (50, 100, 150 Tests etc.).</li> </ul> </li> <li>• Such numbers shall not be more than 2 cm (0.78 in) in height.</li> <li>• A player's initials may be displayed on the back or side of the cap or sunhat. Such initials shall not be more than 2 cm (0.78 in) in height.</li> </ul>	<ul style="list-style-type: none"> <li>• None permitted.</li> </ul>

# ONE DAY INTERNATIONALS PLAYING SWEATER – LONG SLEEVED

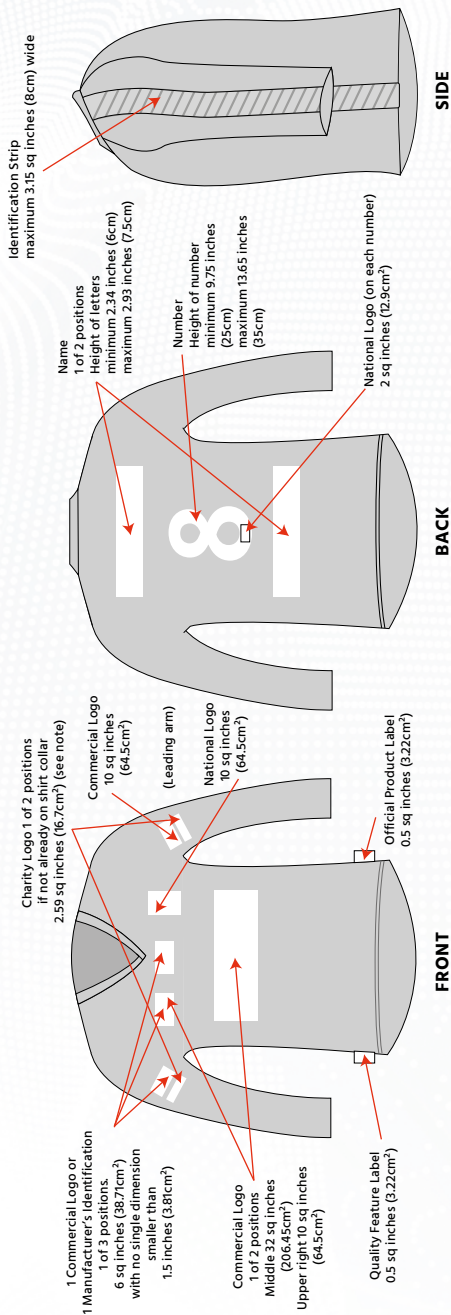

NOTE: Zips, poppers, buttons and Velcro are not permitted anywhere from the bottom up to the chest

## NOTE

COLOUR AND DESIGN	NAME, NUMBER AND INITIALS	OTHER MARKS AND INSIGNIA
<ul style="list-style-type: none"> <li>Each Member Board shall be entitled to choose the colours and design of its playing sweater subject to the following restrictions:               <ul style="list-style-type: none"> <li>The sweaters shall be coloured other than white, cream or any light colour which is likely to make the sighting of a white ball difficult, the decision of the ICC Senior Cricket Operations Manager being final.</li> <li>The colours and design of the playing sweaters (including Logos) shall be uniform to all members of the same team.</li> <li>Each Member Board shall be required to register the pantone colours of its playing clothing with the ICC prior to its use thereof.</li> </ul> </li> </ul>	<ul style="list-style-type: none"> <li>In the event of names and/or numbers of players being carried on the playing sweaters, they shall correctly reflect the identity of the player. The number on the sweaters shall be clearly legible and positioned in the centre back of the sweater.               <ul style="list-style-type: none"> <li>The numbers shall be sewn on or fixed by heat transfer and not affixed by Velcro or any temporary means.</li> <li>The names must be positioned above or below the number on the back of the sweater and the letters used must be clearly legible.</li> <li>The names and numbers may not contain any advertising elements.</li> </ul> </li> <li>In addition, one of the following numbers is permitted to be displayed on the playing sweaters in a position immediately below the National Logo on the front of the sweater:               <ul style="list-style-type: none"> <li>Indicating a player's order of selection for his country, or</li> <li>Indicating the number of caps earned by a player for his country, or</li> <li>Indicating a player's landmark achievement (50, 100, 150 ODIs etc.).</li> </ul> </li> <li>Such numbers shall not be more than 2 cm (0.78 in) in height.</li> <li>A player's initials may be displayed on the chest or sleeve of the long sleeved sweater. Such initials shall not be more than 2 cm (0.78 in) in height.</li> </ul>	<ul style="list-style-type: none"> <li>Nothing contained herein shall prevent the National Logo, the name of the country and/or the national flag or elements contained therein from being incorporated as part of the design of the playing sweaters.</li> <li>Players representing Member Boards who have won the ICC Cricket World Cup may display a symbol on the playing sweater for each of the occasions that this accomplishment has been achieved. No restrictions on position. Each symbol shall not exceed 1 sq cm in size.</li> <li>The name of the opposing touring team or the name of the country being toured as well as the year of such tour may be displayed on the chest of the playing sweater immediately below the National Logo provided such numbers and letters shall not exceed 1 cm (0.4 in) in height.</li> <li>Charity ribbons/logos that are worn on team uniforms must be transferred on to the uniform. Stick on logos are also permitted. Ribbons/logos with pins are not permitted.</li> </ul>



# ONE DAY INTERNATIONALS PLAYING SWEATER – SLEEVELESS

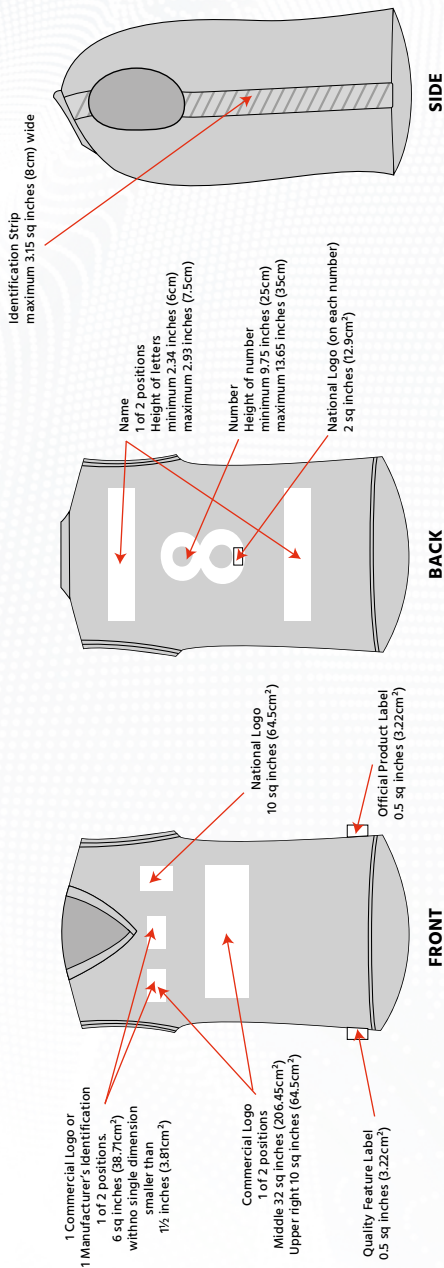

NOTE: Zips, poppers, buttons and Velcro are not permitted anywhere from the bottom up to the chest

## NOTE

COLOUR AND DESIGN	NAME, NUMBER AND INITIALS	OTHER MARKS AND INSIGNIA
<ul style="list-style-type: none"> <li>Each Member Board shall be entitled to choose the colours and design of its playing sweater subject to the following restrictions:               <ul style="list-style-type: none"> <li>The sweaters shall be coloured other than white, cream or any light colour which is likely to make the sighting of a white ball difficult, the decision of the ICC Senior Cricket Operations Manager being final.</li> <li>The colours and design of the playing sweaters (including Logos) shall be uniform to all members of the same team.</li> <li>Each Member Board shall be required to register the pantone colours of its playing clothing with the ICC prior to its use thereof.</li> </ul> </li> </ul>	<ul style="list-style-type: none"> <li>In the event of names and/or numbers of players being carried on the playing sweaters, they shall correctly reflect the identity of the player. The number on the sweaters shall be clearly legible, positioned in the centre back of the sweater.               <ul style="list-style-type: none"> <li>The numbers shall be sewn on or fixed by heat transfer and not affixed by Velcro or any temporary means.</li> <li>The names must be positioned above or below the number on the back of the sweater and the letters used must be clearly legible.</li> <li>The names and numbers may not contain any advertising elements.</li> </ul> </li> <li>In addition, one of the following numbers is permitted to be displayed on the playing sweaters in a position immediately below the National Logo on the front of the sweater:               <ul style="list-style-type: none"> <li>Indicating a player's order of selection for his country, or</li> <li>Indicating the number of caps earned by a player for his country, or</li> <li>Indicating a player's landmark achievement (50, 100, 150 ODIs etc.).</li> <li>Such numbers shall not be more than 2 cm (0.78 in) in height.</li> <li>A player's initials may be displayed on the chest of the sleeveless sweater. Such initials shall not be more than 2 cm (0.78 in) in height.</li> </ul> </li> </ul>	<ul style="list-style-type: none"> <li>Nothing contained herein shall prevent the National Logo, the name of the country and/or the national flag or elements contained therein from being incorporated as part of the design of the playing sweaters.               <ul style="list-style-type: none"> <li>Players representing Member Boards who have won the ICC Cricket World Cup may display a symbol on the chest of the playing sweater for each of the occasions that this accomplishment has been achieved. No restrictions on position. Each symbol shall not exceed 1 sq cm in size.</li> <li>The name of the opposing touring team or the name of the country being toured as well as the year of such tour may be displayed on the chest of the playing sweater immediately below the National Logo provided such numbers and letters shall not exceed 1 cm (0.4 in) in height.</li> </ul> </li> </ul>

# ONE DAY INTERNATIONALS PLAYING SHIRT

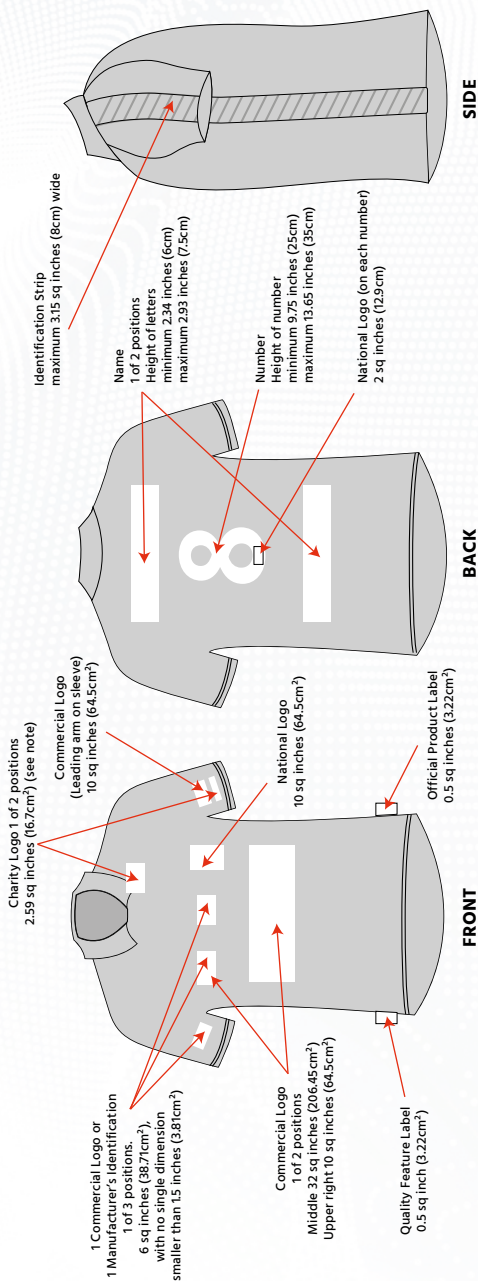

NOTE: Zips, poppers, buttons and Velcro are not permitted anywhere from the bottom up to the chest

## NOTE

COLOUR AND DESIGN	NAME, NUMBER AND INITIALS	OTHER MARKS AND INSIGNIA
<ul style="list-style-type: none"> <li>Each Member Board shall be entitled to choose the colours and design of its playing shirt subject to the following restrictions:               <ul style="list-style-type: none"> <li>The playing shirts shall be coloured other than white, cream or any light colour which is likely to make the sighting of a white ball difficult, the decision of the ICC Senior Cricket Operations Manager being final.</li> <li>The colours and design of the playing shirts (including Logos) shall be uniform to all members of the same team.</li> <li>Playing shirt sleeves may be cut to any length, as long as both sleeves are evenly trimmed and the edges are sewn and hemmed.</li> <li>Each Member Board shall be required to register the pantone colours of its playing clothing with the ICC prior to its use thereof.</li> </ul> </li> </ul>	<ul style="list-style-type: none"> <li>In the event of names and/or numbers of players being carried on the playing shirts, they shall correctly reflect the identity of the player. The number on the shirts shall be clearly legible, positioned in the centre back of the shirt.</li> <li>The numbers shall be sewn on or fixed by heat transfer and not affixed by Velcro or any temporary means.</li> <li>The names must be positioned above or below the number on the back of the shirt and the letters used must be clearly legible.</li> <li>The names and numbers may not contain any advertising elements.</li> <li>In addition, one of the following numbers is permitted to be displayed on the playing shirts in a position immediately below the National Logo on the front of the shirt:               <ul style="list-style-type: none"> <li>Indicating a player's order of selection for his country, or</li> <li>Indicating the number of caps earned by a player for his country, or</li> <li>Indicating a player's landmark achievement (50, 100, 150 ODIs etc.).</li> </ul> </li> <li>Such numbers shall not be more than 2 cm (0.78 in) in height.</li> <li>A player's initials may be displayed on the chest or sleeve of the playing shirt. Such initials shall not be more than 2 cm (0.78 in) in height.</li> </ul>	<ul style="list-style-type: none"> <li>Nothing contained herein shall prevent the National Logo, the name of the country and/or the national flag or elements contained therein from being incorporated as part of the design of the playing shirts.</li> <li>Players representing Member Boards who have won the ICC Cricket World Cup may display a symbol on the chest of the playing shirt for each of the occasions that this accomplishment has been achieved. No restrictions on position. Each symbol shall not exceed 1 sq cm in size.</li> <li>The name of the opposing touring team or the name of the country being toured as well as the year of such tour may be displayed on the chest of the playing shirt immediately below the National Logo provided such numbers and letters shall not exceed 1 cm (0.4 in) in height.</li> <li>Charity ribbons/logos that are worn on team uniforms must be transferred on to the uniform. Stick on logos are also permitted. Ribbons/logos with pins are not permitted.</li> </ul>



# ONE DAY INTERNATIONALS

## PLAYING TROUSERS

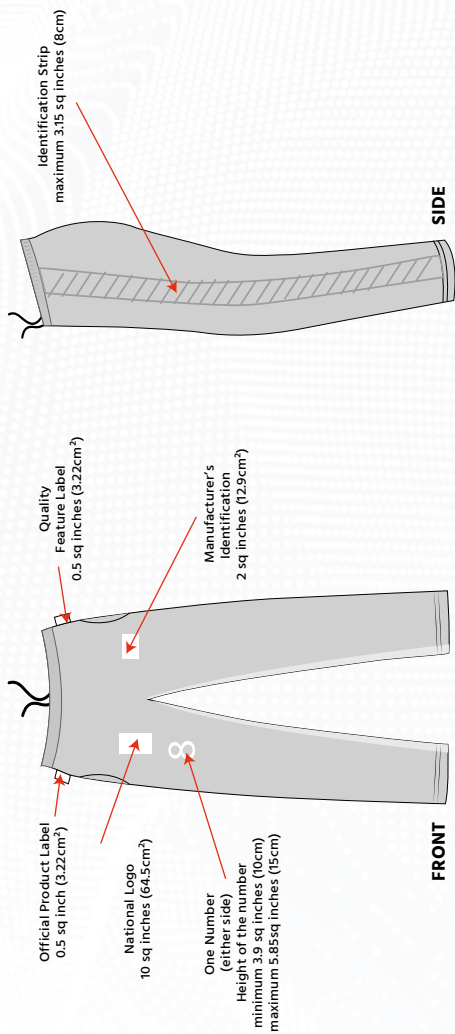

NOTE: Zips, poppers, buttons and Velcro are not permitted anywhere from the knee up to the waist

## NOTE

COLOUR AND DESIGN	NAME, NUMBER AND INITIALS	OTHER MARKS AND INSIGNIA
<ul style="list-style-type: none"> <li>Each Member Board shall be entitled to choose the colours and design of its playing trousers subject to the following restrictions:</li> <li>The playing trousers shall be coloured other than white, cream or any light colour which is likely to make the sighting of a white ball difficult, the decision of the ICC Senior Cricket Operations Manager being final.</li> <li>The colours and design of the playing trousers (including Logos) shall be uniform to all members of the same team.</li> <li>Each Member Board shall be required to register the pantone colours of its playing clothing with the ICC prior to its use thereof.</li> </ul>	<ul style="list-style-type: none"> <li>In the event of numbers being carried on the trousers, they shall be clearly legible and positioned on the front of either leg above the knee.</li> <li>The numbers shall be sewn on or fixed by heat transfer and not affixed by Velcro or any temporary means.</li> </ul>	<ul style="list-style-type: none"> <li>Nothing contained herein shall prevent the National Logo, the name of the country and/or the national flag or elements contained therein from being incorporated as part of the design of the playing trousers.</li> </ul>

# ONE DAY INTERNATIONALS

## PLAYING CAP AND SUN HAT

19.30

19

CLOTHING AND EQUIPMENT  
RULES AND REGULATIONS

National Logo  
10 sq inches (64.5cm<sup>2</sup>)

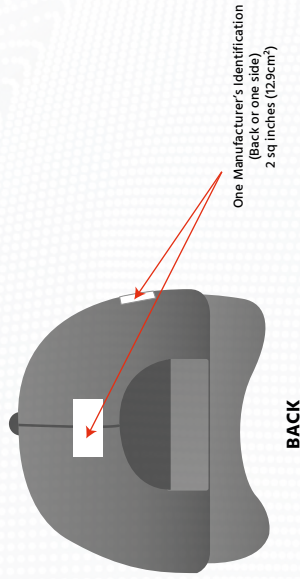
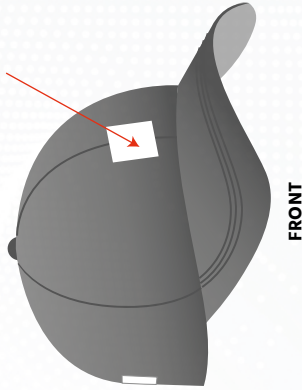

## NOTE

COLOUR AND DESIGN	NAME, NUMBER AND INITIALS	OTHER MARKS AND INSIGNIA
<ul style="list-style-type: none"> <li>• Colour – Caps and sunhats must be the same colour to all members of the same team. As an alternative, a white sunhat may be worn if a team issued coloured sunhat has not been provided.</li> <li>• Design – The design of the cap and sunhat shall be uniform to all members of the same team.</li> </ul>	<ul style="list-style-type: none"> <li>• One of the following numbers is permitted to be displayed on the caps and sunhats in a position immediately below the National Logo or on one side:               <ul style="list-style-type: none"> <li>• Indicating a player's order of selection for his country, or</li> <li>• Indicating the number of caps earned by a player for his country, or</li> <li>• Indicating a player's landmark achievement (50, 100, 150 ODIs etc.).</li> </ul> </li> <li>• Such numbers shall not be more than 2 cm (0.78 in) in height.</li> <li>• A player's initials may be displayed on the back or one side of the cap or sunhat. Such initials shall not be more than 2 cm (0.78 in) in height.</li> </ul>	<ul style="list-style-type: none"> <li>• None permitted.</li> </ul>



# T20 INTERNATIONALS PLAYING SWEATER – LONG SLEEVED

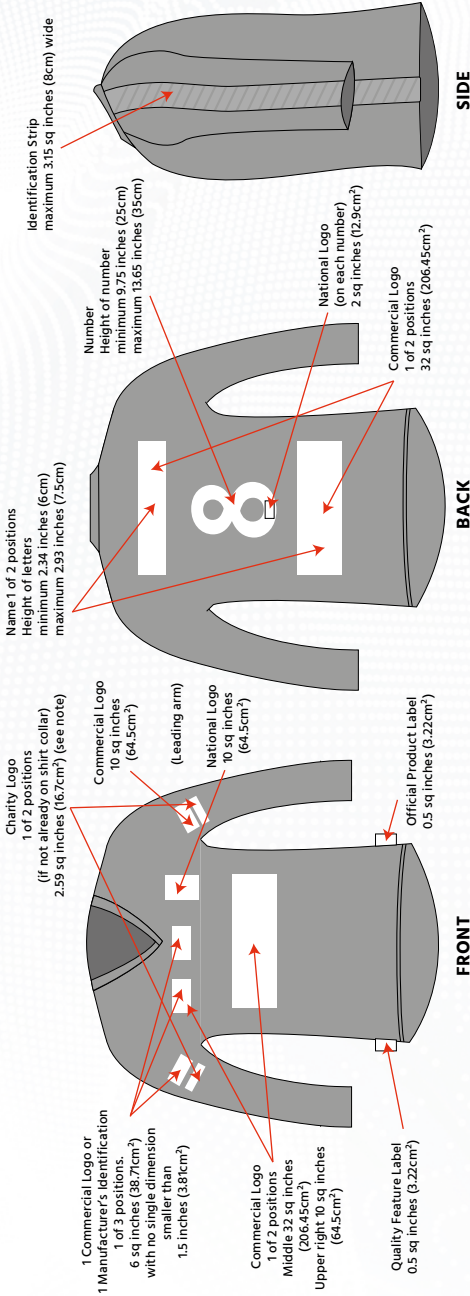

NOTE: Zips, poppers, buttons and Velcro are not permitted anywhere from the bottom up to the chest

## NOTE

COLOUR AND DESIGN	NAME, NUMBER AND INITIALS	OTHER MARKS AND INSIGNIA
<ul style="list-style-type: none"> <li>Each Member Board shall be entitled to choose the colours and design of its playing sweater subject to the following restrictions:               <ul style="list-style-type: none"> <li>The sweaters shall be coloured other than white, cream or any light colour which is likely to make the sighting of a white ball difficult, the decision of the ICC Senior Cricket Operations Manager being final.</li> <li>The colours and design of the playing sweaters (including Logos) shall be uniform to all members of the same team.</li> <li>Each Member Board shall be required to register the pantone colours of its playing clothing with the ICC prior to its use thereof.</li> </ul> </li> </ul>	<ul style="list-style-type: none"> <li>In the event of names and/or numbers of players being carried on the playing sweaters, they shall correctly reflect the identity of the player. The number on the sweaters shall be clearly legible, positioned in the centre back of the sweater.               <ul style="list-style-type: none"> <li>The numbers shall be sewn on or fixed by heat transfer and not affixed by Velcro or any temporary means.</li> <li>The names must be positioned above or below the number on the back of the sweater and the letters used must be clearly legible.</li> <li>The names and numbers may not contain any advertising elements.</li> </ul> </li> <li>In addition, one of the following numbers is permitted to be displayed on the playing sweaters in a position immediately below the National Logo on the front of the sweater:               <ul style="list-style-type: none"> <li>Indicating a player's order of selection for his country, or</li> <li>Indicating the number of caps earned by a player for his country, or</li> <li>Indicating a player's landmark achievement (50, 100, 150 T20is etc).</li> </ul> </li> <li>Such numbers shall not be more than 2 cm (0.78 in) in height.</li> <li>A player's initials may be displayed on the chest or sleeve of the long sleeved sweater. Such initials shall not be more than 2 cm (0.78 in) in height.</li> </ul>	<ul style="list-style-type: none"> <li>Nothing contained herein shall prevent the National Logo, the name of the country and/or the national flag or elements contained therein from being incorporated as part of the design of the playing sweaters.</li> <li>Players representing Member Boards who have won the ICC World Twenty20 may display a symbol on the chest or sleeve of the long sleeved playing sweater for each of the occasions that this accomplishment has been achieved. No restrictions on position. Each symbol shall not exceed 1sq cm in size.</li> <li>The name of the opposing touring team or the name of the country being toured as well as the year of such tour may be displayed on the chest of the playing sweater immediately below the National Logo provided such numbers and letters shall not exceed 1 cm (0.4 in) in height.</li> <li>Charity ribbons/logos that are worn on team uniforms must be transferred on to the uniform. Stick on logos are also permitted. Ribbons/logos with pins are not permitted.</li> </ul>

# T20 INTERNATIONALS PLAYING SWEATER – SLEEVELESS

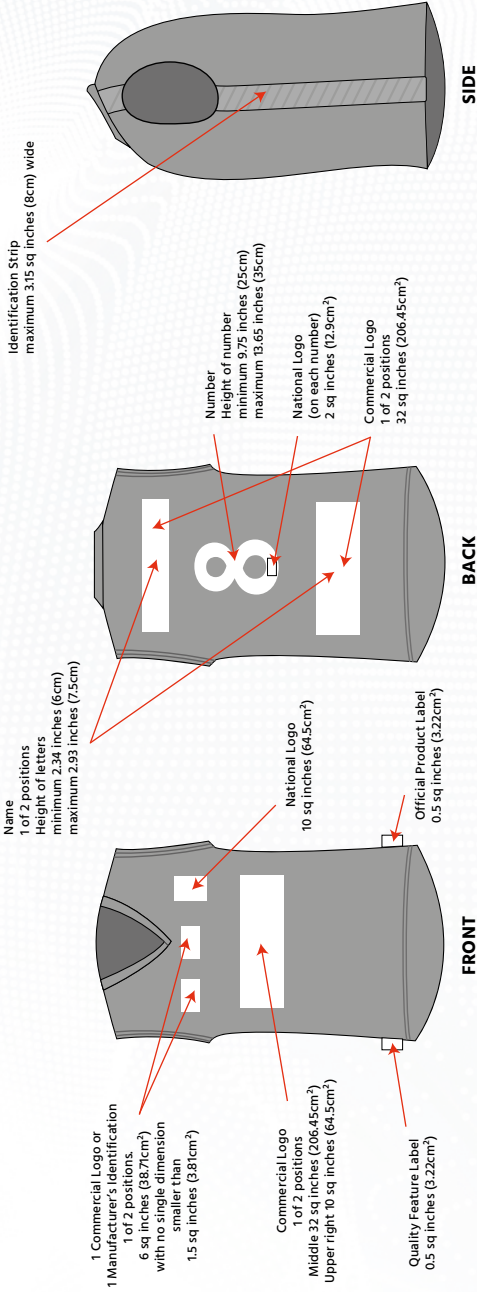

NOTE: Zips, poppers, buttons and Velcro are not permitted anywhere from the bottom up to the chest

## NOTE

COLOUR AND DESIGN	NAME, NUMBER AND INITIALS	OTHER MARKS AND INSIGNIA
<ul style="list-style-type: none"> <li>Each Member Board shall be entitled to choose the colours and design of its playing sweater subject to the following restrictions:               <ul style="list-style-type: none"> <li>The sweaters shall be coloured other than white, cream or any light colour which is likely to make the sighting of a white ball difficult, the decision of the ICC Senior Cricket Operations Manager being final.</li> <li>The colours and design of the playing sweaters (including Logos) shall be uniform to all members of the same team.</li> <li>Each Member Board shall be required to register the pantone colours of its playing clothing with the ICC prior to its use thereof.</li> </ul> </li> </ul>	<ul style="list-style-type: none"> <li>In the event of names and/or numbers of players being carried on the playing sweaters, they shall correctly reflect the identity of the player. The number on the sweaters shall be clearly legible, positioned in the centre back of the sweater.               <ul style="list-style-type: none"> <li>The numbers shall be sewn on or fixed by heat transfer and not affixed by Velcro or any temporary means.</li> <li>The names must be positioned above or below the number on the back of the sweater and the letters used must be clearly legible.</li> <li>The names and numbers may not contain any advertising elements.</li> </ul> </li> <li>In addition, one of the following numbers is permitted to be displayed on the playing sweaters in a position immediately below the National Logo on the front of the sweater:               <ul style="list-style-type: none"> <li>Indicating a player's order of selection for his country, or</li> <li>Indicating the number of caps earned by a player for his country, or</li> <li>Indicating a player's landmark achievement (50, 100, 150 T20is etc).</li> </ul> </li> <li>Such numbers shall not be more than 2 cm (0.78 in) in height.</li> <li>A player's initials may be displayed on the chest of the sleeveless sweater. Such initials shall not be more than 2 cm (0.78 in) in height.</li> </ul>	<ul style="list-style-type: none"> <li>Nothing contained herein shall prevent the National Logo, the name of the country and/or the national flag or elements contained therein from being incorporated as part of the design of the playing sweaters.               <ul style="list-style-type: none"> <li>Players representing Member Boards who have won the ICC World Twenty20 may display a symbol on the chest of the playing sweater for each of the occasions that this accomplishment has been achieved. No restrictions on position. Each symbol shall not exceed 1 sq cm in size.</li> <li>The name of the opposing touring team or the name of the country being toured as well as the year of such tour may be displayed on the playing sweaters immediately below the National Logo provided such numbers and letters shall not exceed 1 cm (0.4 in) in height.</li> </ul> </li> </ul>



# T20 INTERNATIONALS PLAYING SHIRT

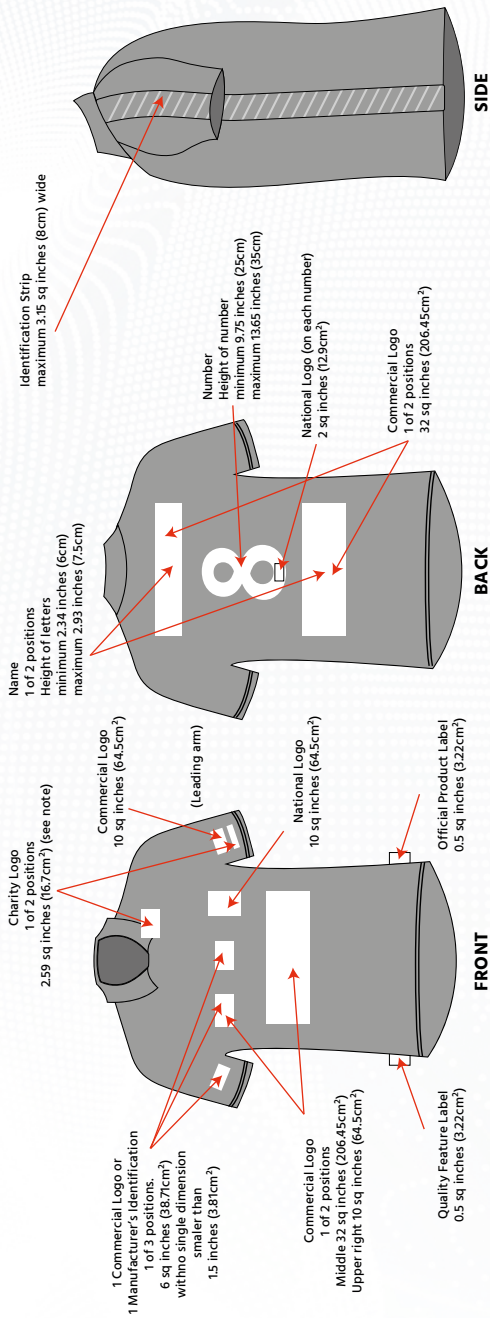

NOTE: Zips, poppers, buttons and Velcro are not permitted anywhere from the bottom up to the chest

## NOTE

COLOUR AND DESIGN	NAME, NUMBER AND INITIALS	OTHER MARKS AND INSIGNIA
<ul style="list-style-type: none"> <li>Each Member Board shall be entitled to choose the colours and design of its playing shirt subject to the following restrictions:               <ul style="list-style-type: none"> <li>The playing shirts shall be coloured other than white, cream or any light colour which is likely to make the sighting of a white ball difficult, the decision of the ICC Senior Cricket Operations Manager being final.</li> <li>The colours and design of the playing shirts (including Logos) shall be uniform to all members of the same team. Playing shirt sleeves may be cut to any length, as long as both sleeves are evenly trimmed and the edges are sewn and hemmed.</li> <li>Each Member Board shall be required to register the pantone colours of its playing clothing with the ICC prior to its use thereof.</li> </ul> </li> </ul>	<ul style="list-style-type: none"> <li>In the event of names and/or numbers of players being carried on the shirts, they shall correctly reflect the identity of the player. The number on the shirts shall be clearly legible, positioned in the centre back of the shirt.</li> <li>The numbers shall be sewn on or fixed by heat transfer and not affixed by Velcro or any temporary means.</li> <li>The names must be positioned above or below the number on the back of the shirt and the letters used must be clearly legible.</li> <li>The names and numbers may not contain any advertising elements.</li> <li>In addition, one of the following numbers is permitted to be displayed on the playing shirts in a position immediately below the National Logo on the front of the shirt:               <ul style="list-style-type: none"> <li>Indicating a player's order of selection for his country, or</li> <li>Indicating the number of caps earned by a player for his country, or</li> <li>Indicating a player's landmark achievement (50, 100, 150 T20is etc).</li> </ul> </li> <li>Such numbers shall not be more than 2 cm (0.78 in) in height.</li> <li>A player's initials may be displayed on the chest or sleeve of the playing shirt. Such initials shall not be more than 2 cm (0.78 in) in height.</li> </ul>	<ul style="list-style-type: none"> <li>Nothing contained herein shall prevent the National Logo, the name of the country and/or the national flag or elements contained therein from being incorporated as part of the design of the playing shirt.</li> <li>Players representing Member Boards who have won the ICC World Twenty20 may display a symbol on the chest of the playing shirt for each of the occasions that this accomplishment has been achieved. No restrictions on position. Each symbol shall not exceed 1.5q cm in size.</li> <li>The name of the opposing touring team or the name of the country being toured as well as the year of such tour may be displayed on the chest of the playing shirt immediately below the National Logo provided such numbers and letters shall not exceed 1 cm (0.4 in) in height.</li> <li>Charity ribbons/logos that are worn on team uniforms must be transferred on to the uniform. Stick on logos are also permitted. Ribbons/logos with pins are not permitted.</li> </ul>

# T20 INTERNATIONALS

## PLAYING TROUSERS

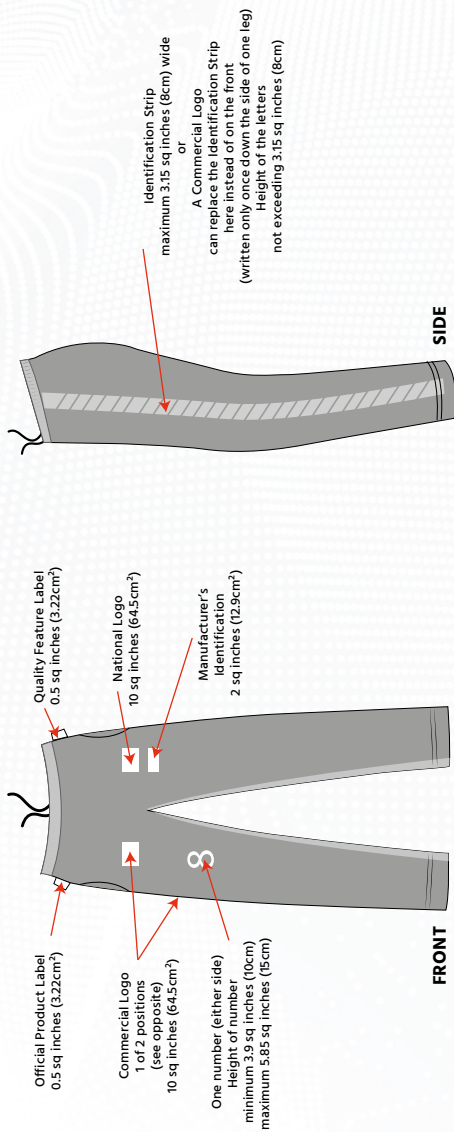

NOTE: Zips, poppers, buttons and Velcro are not permitted anywhere from the knee up to the waist

## NOTE

COLOUR AND DESIGN	NAME, NUMBER AND INITIALS	OTHER MARKS AND INSIGNIA
<ul style="list-style-type: none"> <li>Each Member Board shall be entitled to choose the colours and design of its playing trousers subject to the following restrictions:</li> <li>The playing trousers shall be coloured other than white, cream or any light colour which is likely to make the sighting of a white ball difficult, the decision of the ICC Senior Cricket Operations Manager being final.</li> <li>The colours and design of the playing trousers (including Logos) shall be uniform to all members of the same team.</li> <li>Each Member Board shall be required to register the pantone colours of its playing clothing with the ICC prior to its use thereof.</li> </ul>	<ul style="list-style-type: none"> <li>In the event of numbers being carried on the trousers, they shall be clearly legible and positioned on the front of either leg above the knee.</li> <li>The numbers shall be sewn on or fixed by heat transfer and not affixed by Velcro or any temporary means.</li> </ul>	<ul style="list-style-type: none"> <li>Nothing contained herein shall prevent the National Logo, the name of the country and/or the national flag or elements contained therein from being incorporated as part of the design of the playing trousers.</li> </ul>



# T20 INTERNATIONALS PLAYING CAP AND SUN HAT

National Logo  
10 sq inches (64.5cm<sup>2</sup>)

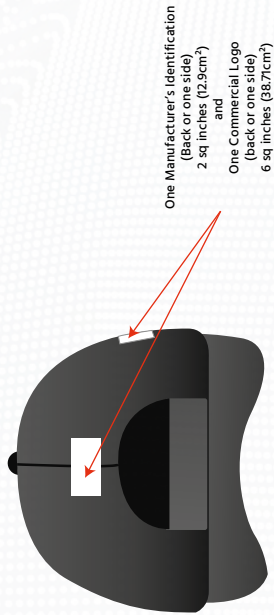
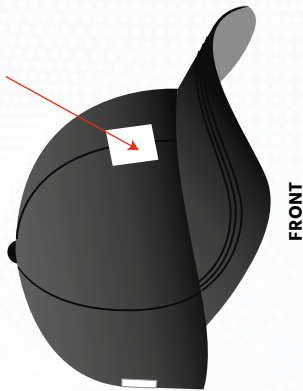

## NOTE

COLOUR AND DESIGN	NAME, NUMBER AND INITIALS	OTHER MARKS AND INSIGNIA
<ul style="list-style-type: none"> <li>• Colour – Caps and sunhats must be the same colour to all members of the same team. As an alternative, a white sunhat may be worn if a team issued coloured sunhat has not been provided.</li> <li>• Design – The design of the cap and sunhat shall be uniform to all members of the same team.</li> </ul>	<ul style="list-style-type: none"> <li>• One of the following numbers is permitted to be displayed on the caps and sunhats in a position immediately below the National Logo or on one side:             <ul style="list-style-type: none"> <li>• Indicating a player's order of selection for his country, or</li> <li>• Indicating the number of caps earned by a player for his country, or</li> <li>• Indicating a player's landmark achievement (50, 100, 150 T20Is etc.).</li> </ul> </li> <li>• Such numbers shall not be more than 2 cm (0.78 in) in height.</li> <li>• A player's initials may be displayed on the back or side of the cap or sunhat. Such initials shall not be more than 2 cm (0.78 in) in height.</li> </ul>	<ul style="list-style-type: none"> <li>• Nothing contained herein shall prevent the National Logo, the name of the country and/or the national flag or elements contained therein from being incorporated as part of the design of the playing cap and sunhat.</li> </ul>

# OTHER CLOTHING

## TEAM TRAINING BIB

One Manufacturer's Logo  
Not exceeding 6 sq inches (38.7cm<sup>2</sup>)  
position optional

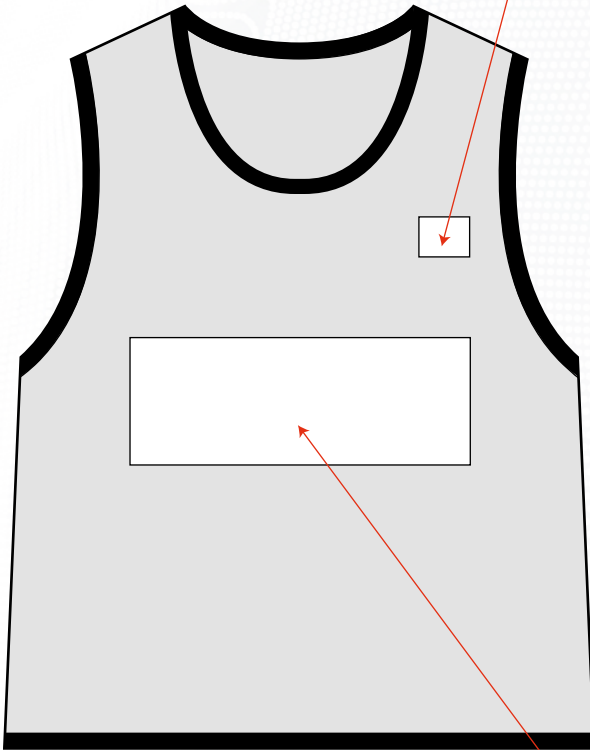

Two Team Sponsor's Logos  
Not exceeding 32 sq inches (206.45cm<sup>2</sup>)  
one on the front and one on the back

## NOTE

COLOUR AND DESIGN	LOGOS
<ul style="list-style-type: none"> <li>• Of one colour and uniform to all members of the same team.</li> <li>• Of a distinguishing colour to that of the playing shirt/sweaters.</li> </ul>	<ul style="list-style-type: none"> <li>• Member Logo, Country Name, Player Name and Number on shirts – No restrictions.</li> </ul>

# OTHER CLOTHING

## T-SHIRTS (worn under playing shirt)



### NOTE

COLOUR AND DESIGN	LOGOS
<ul style="list-style-type: none"><li>• Test Matches – plain white.</li><li>• ODIs/T20Is – plain white or the same colour as the base colour of the playing shirt.</li></ul>	<ul style="list-style-type: none"><li>• No visible logos permitted.</li></ul>



## OTHER CLOTHING

### SKINS (worn under playing shirt)

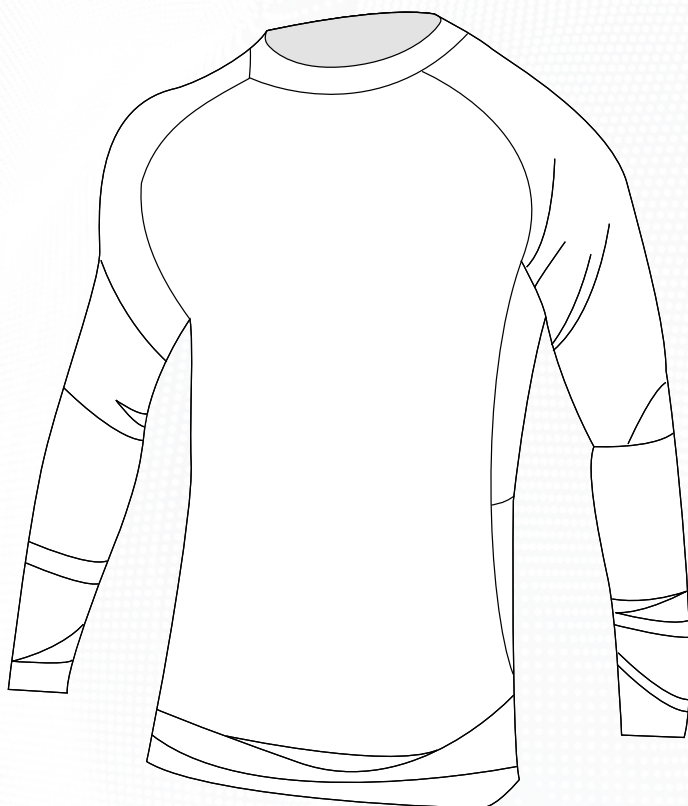

## NOTE

COLOUR AND DESIGN	LOGOS
<ul style="list-style-type: none"><li>• Test Matches – plain white.</li><li>• ODIs/T20Is – of one colour and uniform for all members of the same team; and The same colour as any colour of the playing shirt or trousers.</li></ul> <p>White skins may be worn provided they do not protrude from the shirt sleeves.</p>	<ul style="list-style-type: none"><li>• No visible logos permitted.</li></ul>

# OTHER CLOTHING

## SOCKS

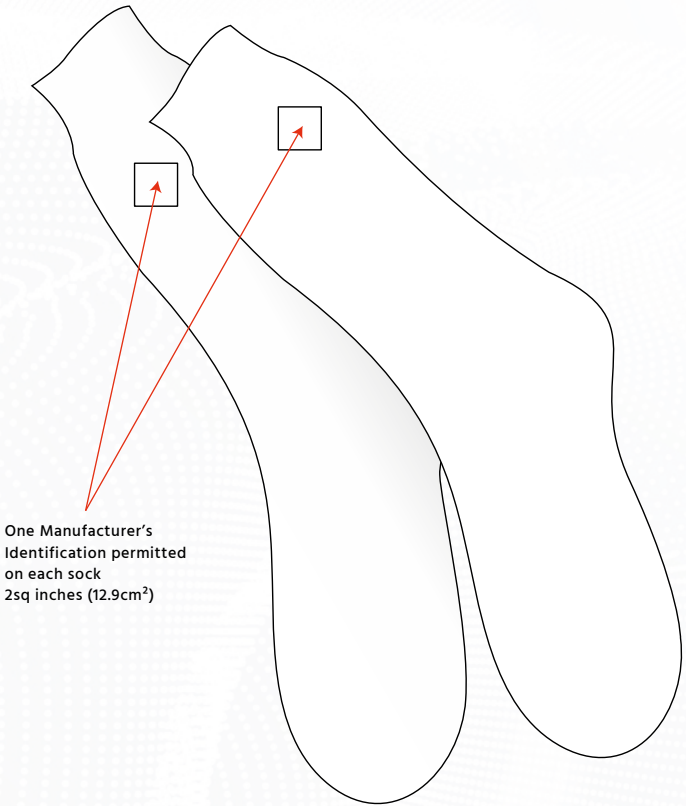

One Manufacturer's  
Identification permitted  
on each sock  
2sq inches (12.9cm<sup>2</sup>)

## NOTE

COLOUR AND DESIGN	LOGOS
<ul style="list-style-type: none"><li>• Test Matches – white, cream or light grey.</li><li>• ODIs/T20Is – white, cream or light grey or the same colour as the base colour of the playing trousers.</li></ul>	<ul style="list-style-type: none"><li>• Apart from Manufacturer's Identification, no visible logos are permitted.</li></ul>

## OTHER CLOTHING

### TURBANS, BANDANAS AND HIJABS

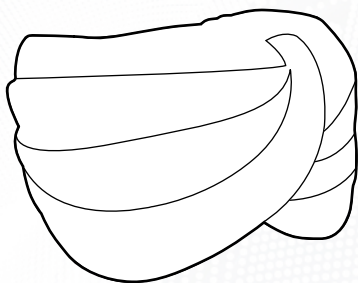

A bandana may only be worn as a cover to a turban or beneath a helmet.



The Hijab shall not cover names, numbers or logos permitted on the playing uniform.

## NOTE

COLOUR AND DESIGN	LOGOS
<ul style="list-style-type: none"><li>• Test Matches – plain black or plain white.</li><li>• ODIs/T20Is – plain black or the same plain base colour as the team cap. White is not permitted.</li></ul>	<ul style="list-style-type: none"><li>• No visible logos permitted.</li></ul>

# OTHER CLOTHING

## HEADBANDS AND WRISTBANDS

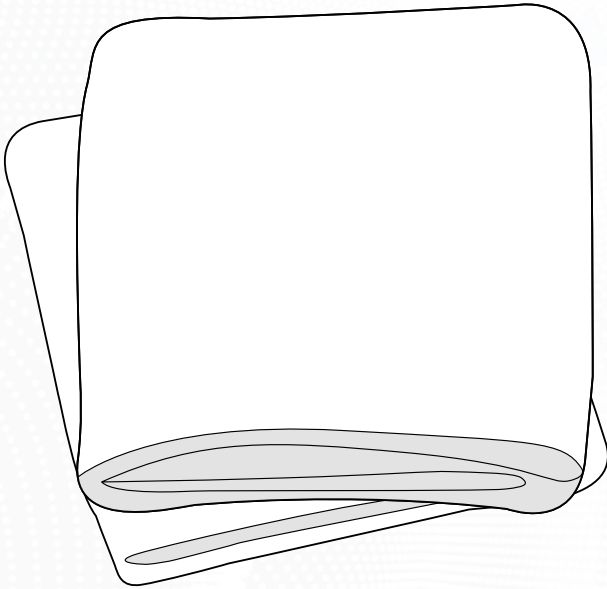

### NOTE

COLOUR AND DESIGN	LOGOS
<ul style="list-style-type: none"><li>• Test Matches – plain white.</li><li>• ODIs/T20Is – plain coloured other than white or any light colour which is likely to make the sighting of the white ball difficult, the decision of the ICC Match Referee being final.</li></ul>	<ul style="list-style-type: none"><li>• No visible logos permitted.</li></ul>

# CRICKET EQUIPMENT

## CRICKET BAT

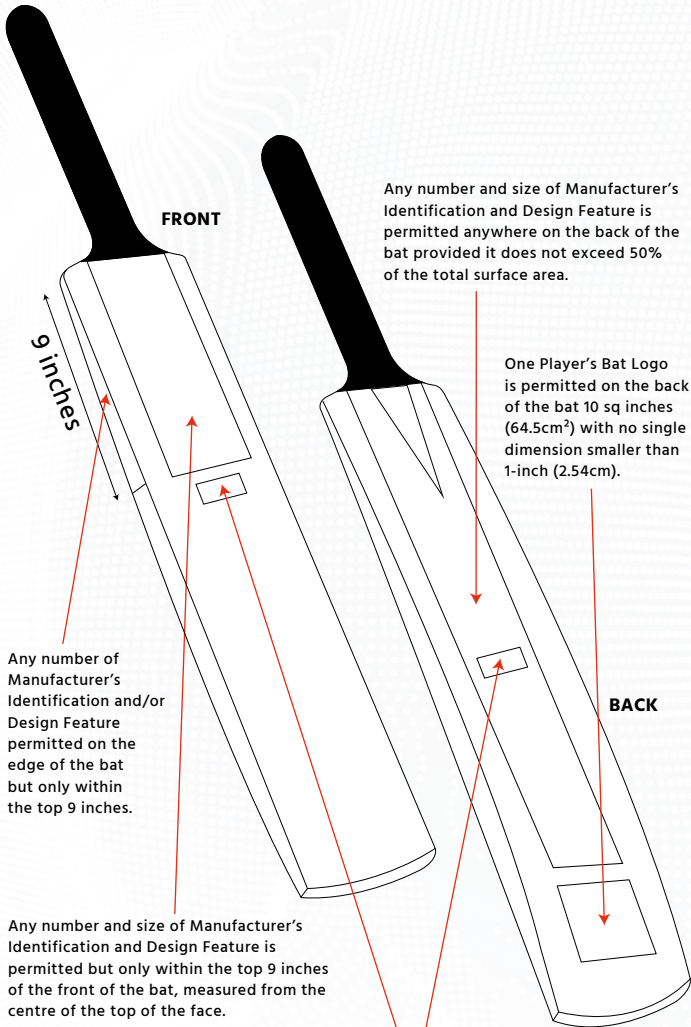

**FRONT**

9 inches

Any number of Manufacturer's Identification and/or Design Feature permitted on the edge of the bat but only within the top 9 inches.

Any number and size of Manufacturer's Identification and Design Feature is permitted but only within the top 9 inches of the front of the bat, measured from the centre of the top of the face.

Any number and size of Manufacturer's Identification and Design Feature is permitted anywhere on the back of the bat provided it does not exceed 50% of the total surface area.

One Player's Bat Logo is permitted on the back of the bat 10 sq inches (64.5cm<sup>2</sup>) with no single dimension smaller than 1-inch (2.54cm).

**BACK**

Two sets of player's initials are permitted. One set is permitted anywhere on the back of the bat. One set is permitted anywhere within the top 10 inches of the face of the bat. Such initials shall not be more than 2cm (0.78 inches) in height.



# CRICKET EQUIPMENT

## WICKET KEEPER GLOVES

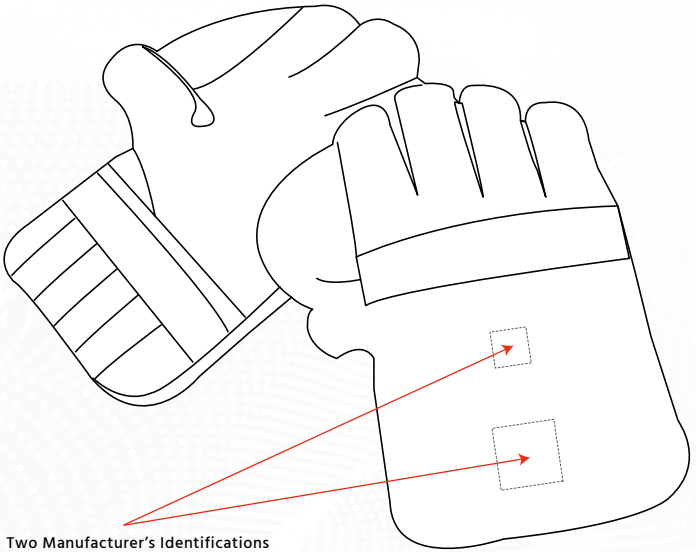

Two Manufacturer's Identifications  
on the back of the each glove.  
1 x 6 sq inches (38.71cm<sup>2</sup>)  
1 x 2 sq inches (12.9cm<sup>2</sup>).

### NOTE

COLOUR AND DESIGN	LOGOS
<ul style="list-style-type: none"><li>Any visible stitching, ventilation, stencil effect or other design aspect of the glove which is in the shape or form of the Manufacturer's Identification will be considered as the Manufacturer's Identification permitted in the diagram.</li></ul>	<ul style="list-style-type: none"><li>No visible logos permitted other than those identified in the diagram.</li></ul>

# CRICKET EQUIPMENT

## BATTING GLOVES

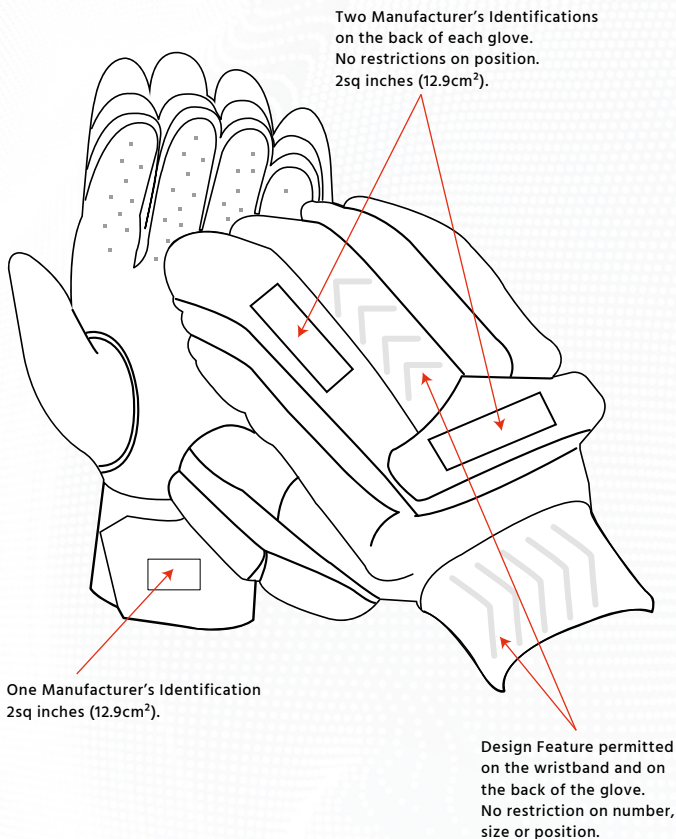

### NOTE

COLOUR AND DESIGN	LOGOS
<ul style="list-style-type: none"><li>• Test Matches – more than 50% of the protective area of the glove must be white.</li><li>• ODIs and T20Is – more than 50% of the protective area of the glove must be white, or the same colour as the base colour of the relevant team's playing shirt.</li></ul>	<ul style="list-style-type: none"><li>• No visible logos permitted other than those identified in the diagram.</li></ul>

# CRICKET EQUIPMENT HELMET

National Logo  
10 sq inches (64.5cm<sup>2</sup>).

Manufacturer's Identification  
on the top of each earpiece  
or the top of both sides of the grid  
2 sq inches (12.9cm<sup>2</sup>).

BACK

Manufacturer's Identification  
on the back of the helmet  
2 sq inches (12.9cm<sup>2</sup>).

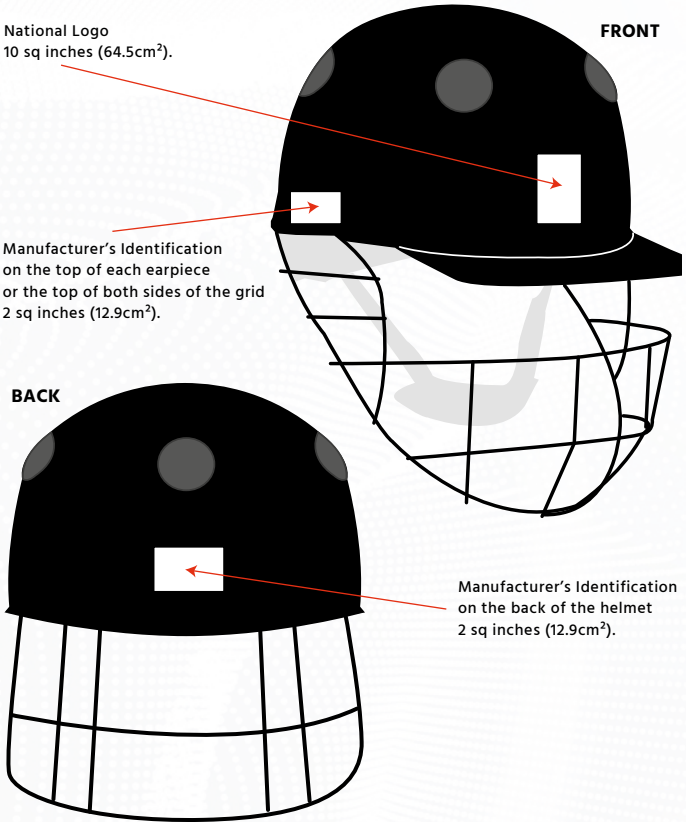

## NOTE

TYPE	COLOUR AND DESIGN	LOGOS
<ul style="list-style-type: none"> <li>While the wearing of helmets is not mandatory in international cricket, effective from 1st January 2017 all helmets worn when batting in international cricket must be certified to BS7928:2013.</li> </ul>	<p>In all formats of the game:</p> <ul style="list-style-type: none"> <li>Helmets shall be one plain colour.</li> <li>The colour of the helmet shall be uniform to all members of the same team.</li> </ul>	<ul style="list-style-type: none"> <li>No visible logos permitted other than those identified in the diagram.</li> </ul>

# CRICKET EQUIPMENT

## WICKET KEEPER PADS

One Manufacturer's Identification in 1 of 2 positions on the front of pad 4 sq inches (25.81cm<sup>2</sup>).

One Manufacturer's Identification inside top of pad no size restriction.

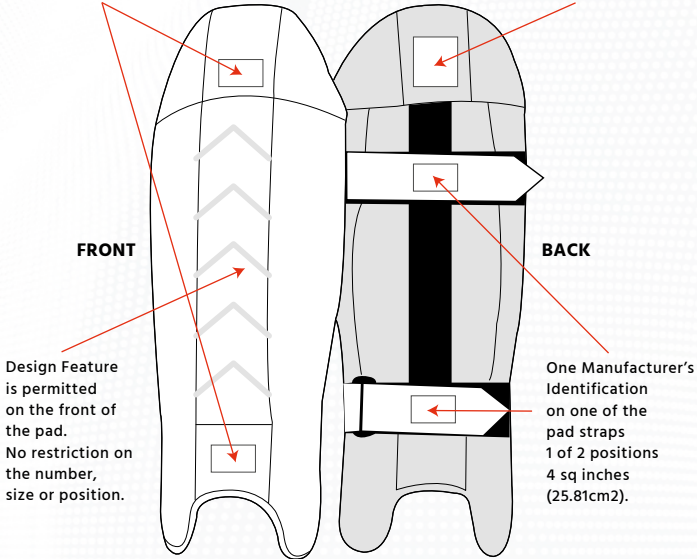

## NOTE

TEST MATCHES	ODIs AND T20Is
<ul style="list-style-type: none"> <li>• Pads shall be plain white save that the straps may be in the house colours of the Manufacturer.</li> <li>• Coloured piping shall be permitted below the ankle strap of the pad only.</li> <li>• Design Feature shall be white only.</li> </ul>	<ul style="list-style-type: none"> <li>• Pads shall be plain coloured other than white or any light colour which is likely to make the sighting of the white ball difficult, the decision of the ICC Match Referee being final. The straps may be in the house colours of the Manufacturer.</li> <li>• Design Feature shall be the same colour as the colour of the pad.</li> <li>• The colour of the pads must be properly maintained. Discoloured or faded pads will not be permitted.</li> <li>• Clads are permitted. A Clad is a coloured cover that goes over a white pad. When used, the Clad logo can replace the existing Manufacturer's Identification on the front of the pad. In such cases, the existing Manufacturer's Identification on the inside top of the pad and the pad straps are still permitted to be displayed.</li> </ul>

# CRICKET EQUIPMENT

## BATTING PADS

Design Feature is permitted on the front of the pad. No restriction on the number, size or position same colour as the pad. (see note)

One Manufacturer's Identification inside top of pad no size restriction.

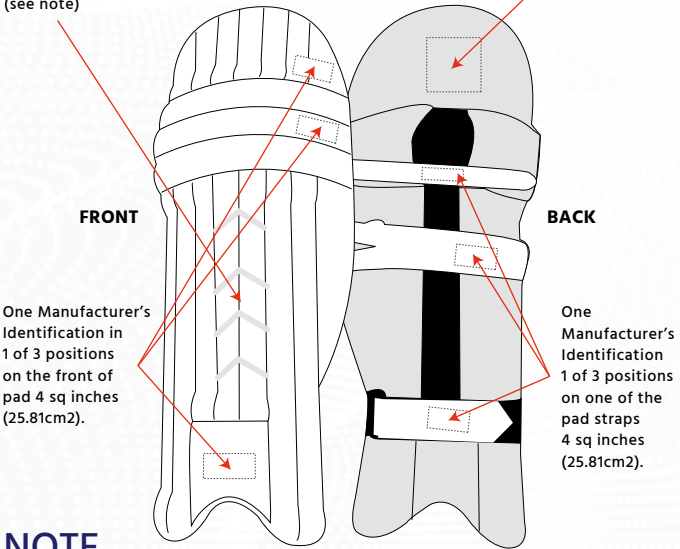

### NOTE

TEST MATCHES	ODIs AND T20Is
<ul style="list-style-type: none"> <li>• Pads shall be plain white save that the straps may be in the house colours of the manufacturer.</li> <li>• Coloured piping shall be permitted below the ankle strap of the pad only.</li> <li>• Design features shall be white only.</li> </ul>	<ul style="list-style-type: none"> <li>• Pads shall be plain coloured other than white or any light colour which is likely to make the sighting of the white ball difficult, the decision of the ICC Match Referee being final. The straps may be in the house colours of the Manufacturer.</li> <li>• Design features shall be the same colour of the pad.</li> <li>• The colour of the pads shall be uniform to all members of the same team.</li> <li>• The colour of the pads must be properly maintained. Discoloured or faded pads will not be permitted.</li> <li>• Clads are permitted. A Clad is a coloured cover that goes over a white pad. When used, the Clad logo can replace the existing Manufacturer's Identification on the front of the pad. In such cases, the existing Manufacturer's Identification on the inside top of the pad and the pad straps are still permitted to be displayed.</li> </ul>



## CRICKET EQUIPMENT SHOES AND BOOTS



Any number and size of Manufacturer's Identification and Design Feature is permitted anywhere on the upper provided it does not exceed 30% of the total surface area. Any written name, initials or word used as a Manufacturer's Identification shall not exceed 2 square inches (12.9cm<sup>2</sup>).

One Manufacturer's Identification may be displayed on the sole. No size restriction.

### NOTE

TEST MATCHES	ODIs AND T20Is
<ul style="list-style-type: none"><li>• Minimum of 70% white inclusive of tongue and laces. No restriction in colour for remaining 30%.</li></ul>	<ul style="list-style-type: none"><li>• Minimum of 70% white inclusive of tongue and laces. No restriction in colour for remaining 30%. Alternatively, the shoe/boot may be in the same colour as the playing kit.</li></ul>

# CRICKET EQUIPMENT

## SUN GLASSES

Two Manufacturers Identification are permitted, one on either side of the frame, not exceeding 0.5 sq inches (3.22cm<sup>2</sup>).

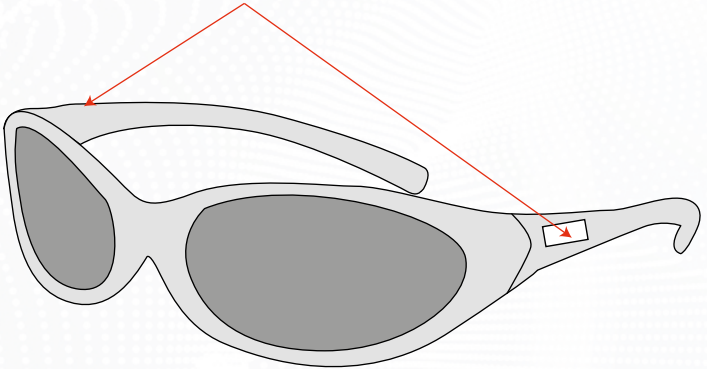

### NOTE

COLOUR AND DESIGN	LOGOS
<ul style="list-style-type: none"><li>No restrictions on colour save that sunglasses strap/band must be of a single colour.</li></ul>	<ul style="list-style-type: none"><li>No visible logos permitted other than those identified in the diagram.</li></ul>

# CRICKET EQUIPMENT

## ARM GUARDS

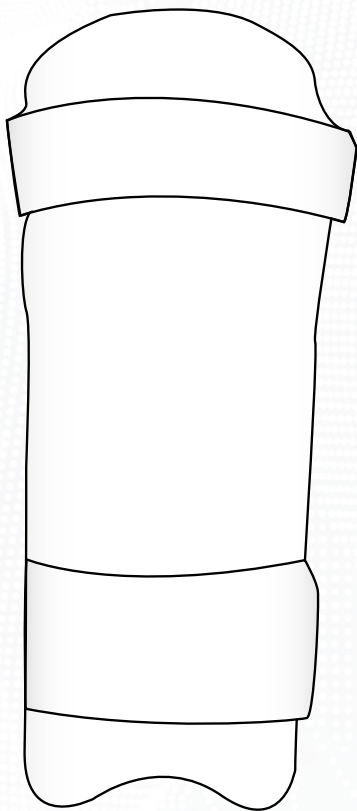

### NOTE

COLOUR AND DESIGN	LOGOS
<ul style="list-style-type: none"><li>• Test Matches – plain white save that the straps may be in the house colours of the Manufacturer.</li><li>• ODIs/T20Is – plain white or the same colour as the base colour of the Playing shirt. Straps may be in the house colours of the Manufacturer.</li></ul>	<ul style="list-style-type: none"><li>• No visible logos.</li></ul>

# CRICKET EQUIPMENT

## FACE PROTECTORS

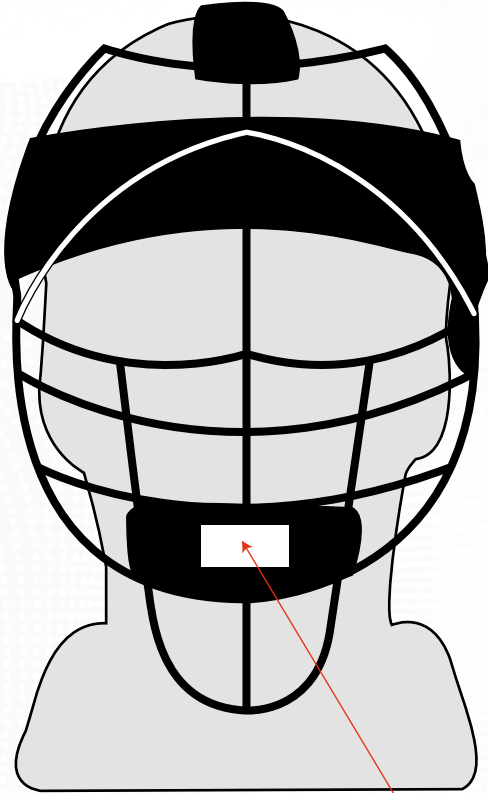

One Manufacturer's Identification is permitted. No restrictions on position. 2 sq inches (12.9cm<sup>2</sup>).

### NOTE

COLOUR AND DESIGN	LOGOS
<ul style="list-style-type: none"> <li>The face protector shall be one plain colour.</li> </ul>	<ul style="list-style-type: none"> <li>No visible logos permitted other than those identified in the diagram.</li> </ul>

# CRICKET EQUIPMENT

## STUMPS

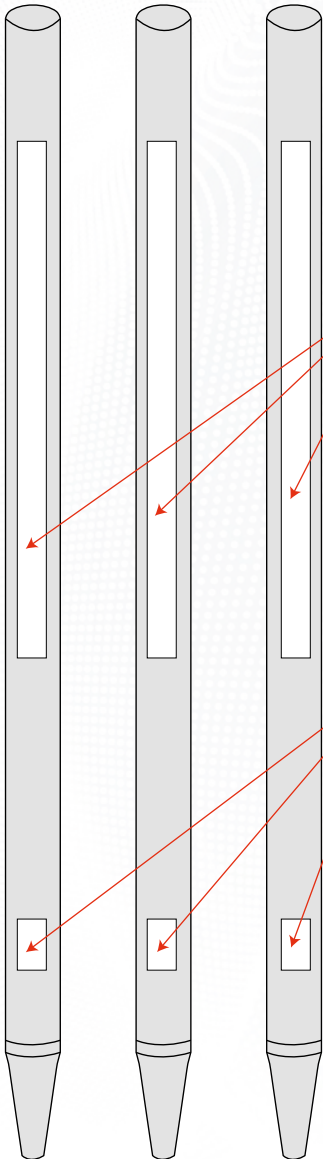

**Test Matches:** No regulation covering the colour of the stumps.

**ODI's & T20's:** No regulation covering the colour of the stumps save that the bails shall be of a distinguishing colour to that of the stumps.

**Logos:** The Event Logo and / or the Logo of the series or the sponsors may be displayed on each of the stumps. No size restriction. National Logos are not permitted on the stumps.

Two Manufacturer's Identifications are permitted on each stump—one on the front and one on the back not exceeding 2sq inches (12.9cm<sup>2</sup>).



# CRICKET EQUIPMENT

## THIGH PADS, SHIN PADS AND OTHER EQUIPMENT

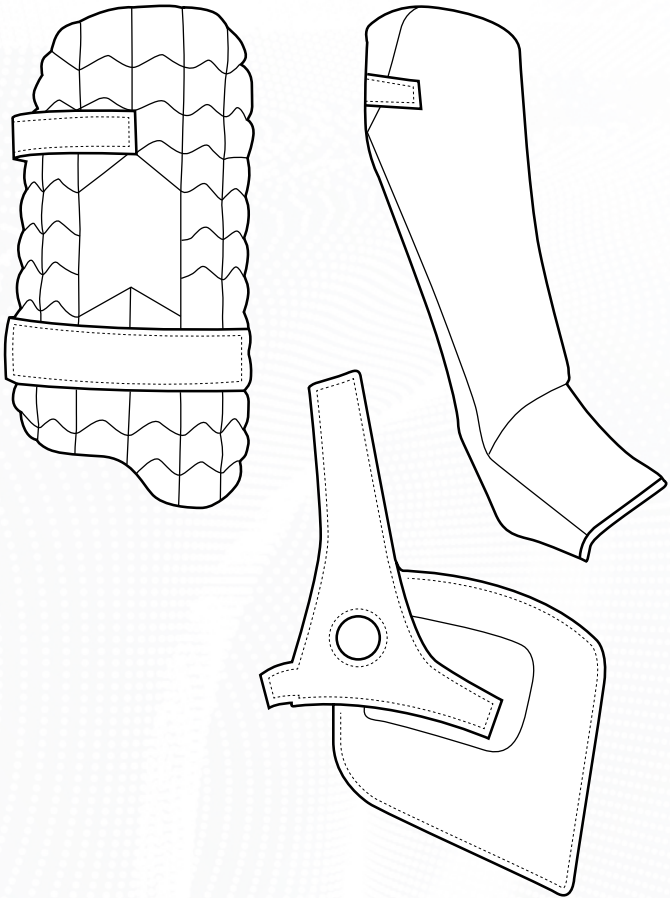

### NOTE

COLOUR AND DESIGN	LOGOS
<ul style="list-style-type: none"><li>No restriction on colours save that these items must be worn under playing clothing and shall not be visible.</li></ul>	<ul style="list-style-type: none"><li>No visible logos shall be permitted.</li></ul>

## APPENDIX 2

### DISCIPLINARY PROCESS

#### ARTICLE 1 – REPORTING AN ALLEGED OFFENCE

- 1.1 Any one of the following individuals can report an alleged offence under the Regulations by lodging a report in the manner described in Article 1.2 below (a 'Report'):
- 1.1.1 any Umpire;
  - 1.1.2 any Referee; or
  - 1.1.3 any member of the ICC's Cricket Operations Department.
- 1.2 A Report must be lodged by way of an e-mail to the ICC's Senior Cricket Operations Manager. All Reports must (a) clearly identify the person lodging the Report; (b) identify the relevant International Match in which the breach was alleged to have been committed; (c) identify the individual, whether that be a player, team official of Board, who is alleged to have committed the offence; and (d) in the case of non-televised matches, include a photograph of the offending clothing or equipment taken during the International Match where the breach was alleged to have been committed. In the case of Reports lodged by any of the individuals listed in Articles 1.1.1 and 1.1.2, in addition to the e-mail, details of the alleged breach shall be included on the Umpire or Match Referee's daily log (where applicable) filed with the ICC Cricket Operations Department at the end of each day's play.
- 1.3 All Reports must be lodged with the ICC's Senior Cricket Operations Manager within seven (7) days of conclusion of the relevant International Match.
- 1.4 Where a player, team official or Board is alleged to have committed more than one breach of the Regulations during an International Match (whether arising out of the same set of facts or otherwise), then a separate Report should be filed in accordance with this Article 1 for each of the breaches that are alleged to have been committed.

#### ARTICLE 2 – NOTIFICATION PROCEDURE

- 2.1 Where the ICC's Senior Cricket Operations Manager receives a Report, he/she must promptly conduct a review to determine whether the player, team official or Board named in the Report has a case to answer.
- 2.2 If the initial review of the Report reveals that there is no case to answer, then the ICC's Senior Cricket Operations Manager shall notify the person who filed the Report of that fact, and the matter shall not proceed any further.
- 2.3 If the initial review of the Report reveals that there is a case to answer, then the ICC's Senior Cricket Operations Manager shall promptly provide a copy of the Report, together with copies of the photographic/video snapshot evidence supporting the Report and Form 'CE Not 1' (such documents comprising the 'Notice of Charge') to the following individuals:
- 2.3.1 the player or team official named in the Report (where relevant);
  - 2.3.2 the Team Manager of the relevant player or team official named in the Report (where relevant); and
  - 2.3.3 the CEO of the Board (or his/her designee) to which the relevant player or team official is affiliated, or, in the case of a breach by the Board itself, the CEO of the relevant Board (or his/her designee).

- 2.4** The Notice of Charge shall specify that the player, team official or relevant Board shall have the following options which must be exercised through notice to the ICC's Senior Cricket Operations Manager within seven (7) days of receipt by the player, team official or Board of the Notice of Charge:
- 2.4.1** he/she/it may admit the offence charged and accede to the sanction proposed in the Notice of Charge (which sanction shall comply with the sanctions set out in Article 4), in which case adjudication shall not be required and no further action shall be taken; or
  - 2.4.2** he/she/it may admit the offence charged but dispute the sanction proposed in the Notice of Charge, in which case the matter shall proceed to adjudication in accordance with Article 3; or
  - 2.4.3** he/she/it may deny the offence charged, in which case, the matter shall proceed to adjudication in accordance with Article 3.
- 2.5** Where the player, team official or Board either disputes the sanction proposed under Article 2.4.2, or denies the offence charged under Article 2.4.3, his/her/its response to the Notice of Charge must be supported by a written statement, in English, explaining why the player, team official or Board does not admit the offence and/or accept the proposed sanction, and any documentary evidence that the player, team official or National Cricket Federation relies on in support.

### ARTICLE 3 – THE DISCIPLINARY PROCEDURE

- 3.1** Where a matter proceeds to adjudication under Article 2.4.2 or 2.4.3, then the case shall be referred to the ICC's General Manager – Cricket who shall decide the matter solely on the basis of the Notice of Charge and any written statement filed by the player, team official or Board in accordance with Article 2.5. The ICC's General Manager – Cricket shall not hold an oral hearing. However, should the ICC's General Manager – Cricket consider that further information is necessary to allow him to make his decision, he shall be entitled to obtain such further information before making his decision, and the relevant player, team official or Board shall assist him in this regard, where requested. In considering the matter, the ICC's General Manager – Cricket shall be entitled to consult with the ICC's General Counsel.
- 3.2** Save in exceptional circumstances, the ICC's General Manager – Cricket shall notify his written reasoned decision, setting out: (a) the finding as to whether an offence under the Regulations has been committed; (b) the sanction, if any, to be imposed (in accordance with Article 4); (c) details of which match or matches any suspension is to be applied to; and (d) any right of appeal that exists pursuant to Article 5, within seven (7) days of receipt of the response to the Notice of Charge. A copy of the decision shall be sent to the CEO of the player or team official's Board (or his/her designee) and the ICC's Senior Cricket Operations Manager.
- 3.3** Subject only to the rights of appeal under Article 5, the ICC's General Manager – Cricket Operations' decision shall be the full, final and complete disposition of the matter and will be binding on all parties.

**ARTICLE 4 – SANCTIONS**

- 4.1** Where the ICC's Senior Cricket Operations Manager determines that there is a case to answer in accordance with Article 2.1, in issuing the Notice of Charge, he/she shall specify (on Form Not 1) the appropriate sanction to be imposed on the player, team official or Board.
- 4.2** In addition, where a matter comes before the ICC's General Manager – Cricket in accordance with either Article 2.4.2 or 2.4.3, and he/she determines that an offence under these Regulations has been committed, he/she will be required to impose an appropriate sanction on the player, team official or Board.
- 4.3** In order to determine the sanction that is to be imposed in each case, the ICC's Senior Cricket Operations Manager or ICC's General Manager – Cricket (as appropriate) must first consider whether the player, team official or National Cricket Federation has previously been found guilty of an offence in the same category under the Regulations within a period of twelve (12) months prior to the date on which the alleged offence took place.

**NOTE:** For example, if a player is found to have breached these Regulations in respect of a Commercial Logo, he/she shall only be considered to have committed a repeat offence if, within the twelve month period prior to the date of the alleged offence, he/she was found guilty of a breach of these Regulations in relation to any Commercial Logo. If the previous breach had related, for example, to a Charity Logo, it would not count as a repeat offence for the purposes of this Article 4.3.

- 4.4** Once the ICC's Senior Cricket Operations Manager or ICC's General Manager – Cricket (as appropriate) has established whether this is a repeat offence within the relevant twelve month period, then he/she shall go on to take into account any other factors that he/she deems relevant and appropriate to the mitigation or aggravation of the nature of the offence (including, without limitation, the nature and frequency of any previous offences under the Regulations) before determining, in accordance with the following table, what the appropriate sanction should be.



CATEGORY OF OFFENCE	SANCTION – FIRST OFFENCE	SANCTION – SECOND OFFENCE WITHIN 12 MONTHS	SANCTION – THIRD OFFENCE WITHIN 12 MONTHS	SANCTION – FOURTH OFFENCES WITHIN 12 MONTHS
<b>PLAYERS</b>				
Non-Commercial Logo, Charity Logo or other breach	Reprimand.	The imposition of a fine of 25% of the applicable Match Fee.	The imposition of a fine of 50% of the applicable Match Fee.	The imposition of a fine of 75% of the applicable Match Fee.
Manufacturer's Logo	The imposition of a fine of 25% of the applicable Match Fee.	The imposition of a fine of 50% of the applicable Match Fee.	The imposition of a fine of 100% of the applicable Match Fee.	The imposition of a 1 match suspension.
Player's Bat Logo (excluding Charity Logo)	The imposition of a fine of 50% of the applicable Match Fee.	The imposition of a fine of 75% of the applicable Match Fee.	The imposition of a fine of 100% of the applicable Match Fee.	The imposition of a 1 match suspension.
Commercial Logo	The imposition of a fine of 50% of the applicable Match Fee.	The imposition of a fine of 75% of the applicable Match Fee.	The imposition of a fine of 100% of the applicable Match Fee.	The imposition of a 1 match suspension.
Betting Logo	The imposition of a fine of 75% of the applicable Match Fee.	The imposition of a fine of 100% of the applicable Match Fee.	The imposition of a 1 match suspension.	The imposition of a minimum 2 match suspension.
Non-Compliant Helmet	First Warning.	Second Warning.	The imposition of a 1 match suspension.	The imposition of a 2 match suspension.
<b>National Cricket Federations</b>				
All Categories	Warning and/or the imposition of a fine up to a maximum of US\$25,000.	The imposition of a fine up to a maximum of US\$25,000.	The imposition of a fine up to a maximum of US\$25,000.	The imposition of a fine up to a maximum of US\$25,000.

**NOTE: For the purposes of this Appendix 2, Match Fee means the designated match fee (which is to be used for the purposes of calculating sanctions in accordance with Article 4 of Appendix 2) as set out in Appendix 3 to these Regulations.**



- 4.5 Where a player or team official has been suspended for a specific number of matches, the suspension will be applied in accordance with the following principles:
- 4.5.1 the ICC's Senior Cricket Operations Manager or the ICC's General Manager – Cricket (as appropriate) shall have regard to the player or team official's participation in the various formats of International Matches over the previous two years in order to determine (to the best of his/her ability) which of the forthcoming International Matches the player or team official is most likely to participate in;
- 4.5.2 in so far as is reasonably possible, the ICC's Senior Cricket Operations Manager or the ICC's General Manager – Cricket (as appropriate) shall apply the suspension to the subsequent International Matches in which the player or team official is likely to participate in, on a chronological basis immediately following the announcement of the decision;
- 4.5.3 where a player or team official has his/her suspension applied to an International Match that is subsequently cancelled, postponed or otherwise abandoned prior to the actual day on which it is scheduled to take place, then such suspension must be reallocated to the next subsequent International Match in which the player or team official is likely to participate in. Where an International Match is cancelled, postponed or otherwise abandoned at any time on the actual day on which it is scheduled to take place, then the suspension will remain allocated to that International Match, irrespective of such cancellation, postponement or abandonment.

#### EXAMPLES OF THE APPLICATION OF SUSPENSION POINTS:

- 1 Where a player's playing history suggests that he/she is most likely to represent his National Cricket Federation in Test Matches only, then the suspension shall be applied to his/her future participation in Test Matches only, so that a one match suspension would be applied to the Test Match immediately following the announcement of the decision, notwithstanding that the National Cricket Federation might be participating in intervening One Day International Matches and/or Twenty20 International Matches.
- 2 Where a player's playing history suggests that he/she is likely to be selected to represent his National Cricket Federation in all formats of International Matches, then the suspension shall be applied to his/her future participation in all International Matches in the sequential order in which such International Matches take place immediately following the announcement of the decision. For example, if a player received a two match suspension, and the following chronological list of potential playing fixtures represented the player's National Cricket Federation's upcoming International Matches:
  - Announcement of decision
  - One-Day International Match – **Match A**
  - Test Match – **Match B**
  - Twenty20 International Match – **Match C**

the player's suspension would be applied to Matches A and B, and he would be entitled to return to participation in Match C.

- 4.6** Where a fine is imposed against a player or team official, then such fine must be paid: (a) by the player or team official (and not any third party, including a Board); (b) to the player or team official's Board (for onward transmission to the ICC) within one calendar month of receipt of the decision imposing the fine. However, the ICC will consider any request from any player or team official to make payment of such fines over a prolonged period of time on the grounds of financial hardship. Should any fine (or agreed part-payment or instalment thereof) not be paid to the relevant Board within such deadline or by the time of the next agreed payment date, the player or team official may not play, coach or otherwise be involved in any capacity in any International Match until such payment has been satisfied in full.
- 4.7** Where a player or team official has had a suspension imposed against him/her, he/she may not play, coach or otherwise participate or be involved in any capacity in the International Match(es) which are covered by the application of his suspension as determined in accordance with Article 4.5.

**NOTE:** For the avoidance of any doubt, a player who has had a suspension imposed against him/her shall not, during the International Matches which are covered by his/her suspension:

- a) be nominated as, or carry out any of the duties or responsibilities of, a substitute fielder; or
- b) enter any part of the playing area (which shall include, for the avoidance of doubt, the field of play and the area between the boundary and perimeter boards) at any time, including during any scheduled or unscheduled breaks in play.

In addition, a team official so sanctioned shall not be permitted to enter the player's dressing room (including the viewing areas) during any International Match covered by his suspension. Players so sanctioned, however, will be permitted to enter the players' dressing room provided that the players' dressing room (or any part thereof) for the relevant International Match is not within the player area described in (b) above (for example, no such Player shall be permitted access to an on-field 'dug-out').

Finally, any player or team official so sanctioned shall not be prevented from attending any post-match ceremonies or presentations taking place anywhere on the field of play or otherwise following the conclusion of an International Match covered by his/her suspension.

- 4.8** Once any suspension has expired, the player or team official will automatically become re-eligible to participate in International Matches provided that he/she has paid, in full, all amounts forfeited under these Regulations, including any fines that may have been imposed against him/her.

## ARTICLE 5 – APPEALS

- 5.1 Appeals from decisions in relation to which a reprimand and/or fine is imposed
- 5.1.1 Decisions made under these Regulations by the ICC's General Manager – Cricket in relation to which a reprimand and/or fine is imposed shall be non-appealable and shall remain the full and final decision in relation to the matter.
- 5.2 Appeals from decisions in relation to which a suspension is imposed
- 5.2.1 Decisions made by the ICC's General Manager – Cricket in relation to which a suspension is imposed may be challenged solely by appeal as set out in this Article 5.2. Such decision shall remain in effect while under appeal unless the ICC's Chief Executive Officer properly convened to hear the appeal orders otherwise.
- 5.2.2 The only parties who may appeal a decision of this nature shall be the player, team official or Board found guilty of an offence under these Regulations.
- 5.2.3 Any notice to appeal under this Article must be lodged with the ICC's Chief Executive Officer (with a copy to the ICC's General Counsel) within fourteen (14) days of receipt of the written decision of the ICC's General Manager – Cricket (the **Notice of Appeal**). In cases where a player or team official files a Notice of Appeal, a copy of such notice will also be provided to the CEO of the National Cricket Federation (or his/her designee) to which the player or team official is affiliated. The Notice of Appeal shall include a written statement setting out, in detail, the grounds for appeal of the decision, together with any documents that the player, team official or Board wishes to rely on in support of the appeal.
- 5.2.4 Thereafter, the ICC's Chief Executive Officer shall decide the matter solely on the basis of the Notice of Appeal and supporting documents, and the original Notice of Charge. The ICC's Chief Executive Officer shall not hold an oral hearing. However, should the ICC's Chief Executive Officer consider that further information is necessary to allow him to make his decision, he shall be entitled to obtain such further information before making his decision, and the relevant player, team official or Board shall assist him in that regard, where requested. In considering the matter, the ICC's Chief Executive Officer shall be entitled to consult with the ICC's General Counsel.
- 5.2.5 Save in exceptional circumstances, the ICC's Chief Executive Officer shall notify his written reasoned decision, setting out: (a) the finding as to whether an offence under the Regulations has been committed; (b) the sanction, if any, to be imposed (in accordance Article 4); and (c) details of which match or matches any suspension is to be applied to, within fourteen (14) days of receipt of the receipt of the Notice of Appeal. A copy of the decision shall be sent to the CEO of the player or team official's Board (or his/her designee) and the ICC's Senior Cricket Operations Manager.
- 5.2.6 Any decision made by the ICC's Chief Executive Officer under this Article 5.2 shall be the full, final and complete disposition of the matter and will be binding on all parties.

- 5.3 No appeal in relation to an accepted sanction
- 5.3.1 For the avoidance of doubt, where a player, team official or Board admits the offence charged and accedes to the sanction specified in the Notice of Charge in accordance with the procedure described in Article 2.4.1, the player, team official or Board waives his/her/its right to any appeal against the imposition of such a sanction.

## ARTICLE 6 – RECOGNITION OF DECISIONS

- 6.1 Any final adjudications under these Regulations shall be recognised and respected by the ICC and its Member Boards automatically upon receipt of notice of the same, without the need for any further formality. Each of the ICC and its Member Boards shall take all steps legally available to it to enforce and give effect to such decisions.
- 6.2 It shall be a condition of membership of the ICC that all National Cricket Federations shall comply with the Regulations.

## ARTICLE 7 – GOVERNING LAW

- 7.1 These Regulations are governed by and shall be construed in accordance with English law. Strictly without prejudice to the arbitration provisions of Articles 3 and 5 of the Regulations, disputes relating to the Regulations shall be subject to the exclusive jurisdiction of the English courts.



## APPENDIX 3

### MATCH FEES

Unless otherwise agreed in advance of an International Match or ICC Event, for the purposes of any sanctions that are to be applied pursuant to these Regulations, the following designated Match Fees shall apply:

TYPE OF INTERNATIONAL MATCH	DESIGNATED MATCH FEE
Any men's Test Match, One Day International Match or Twenty20 International Matches.	A country-specific amount which is to be determined by the ICC's Chief Executive's Committee in consultation with the relevant National Cricket Federations.
All other International Matches.	No Match Fee will be applied. Accordingly, neither the ICC's Senior Cricket Operations Manager or the ICC's General Manager – Cricket shall have jurisdiction under these Regulations to impose any financial sanctions against any Player or Player Support Personnel for a breach of these Regulations. However the remaining range of permissible sanctions (set out in the tables in Article 4.4 of Appendix 2) shall be available to ICC's Senior Cricket Operations Manager or the ICC's General Manager – Cricket in full.

For the avoidance of doubt, the designated Match Fee to be applied for the purposes of an offence committed by a Player Support Personnel shall be the same as that which would be applied to a Player from the same National Cricket Federation participating in the same International Match.